

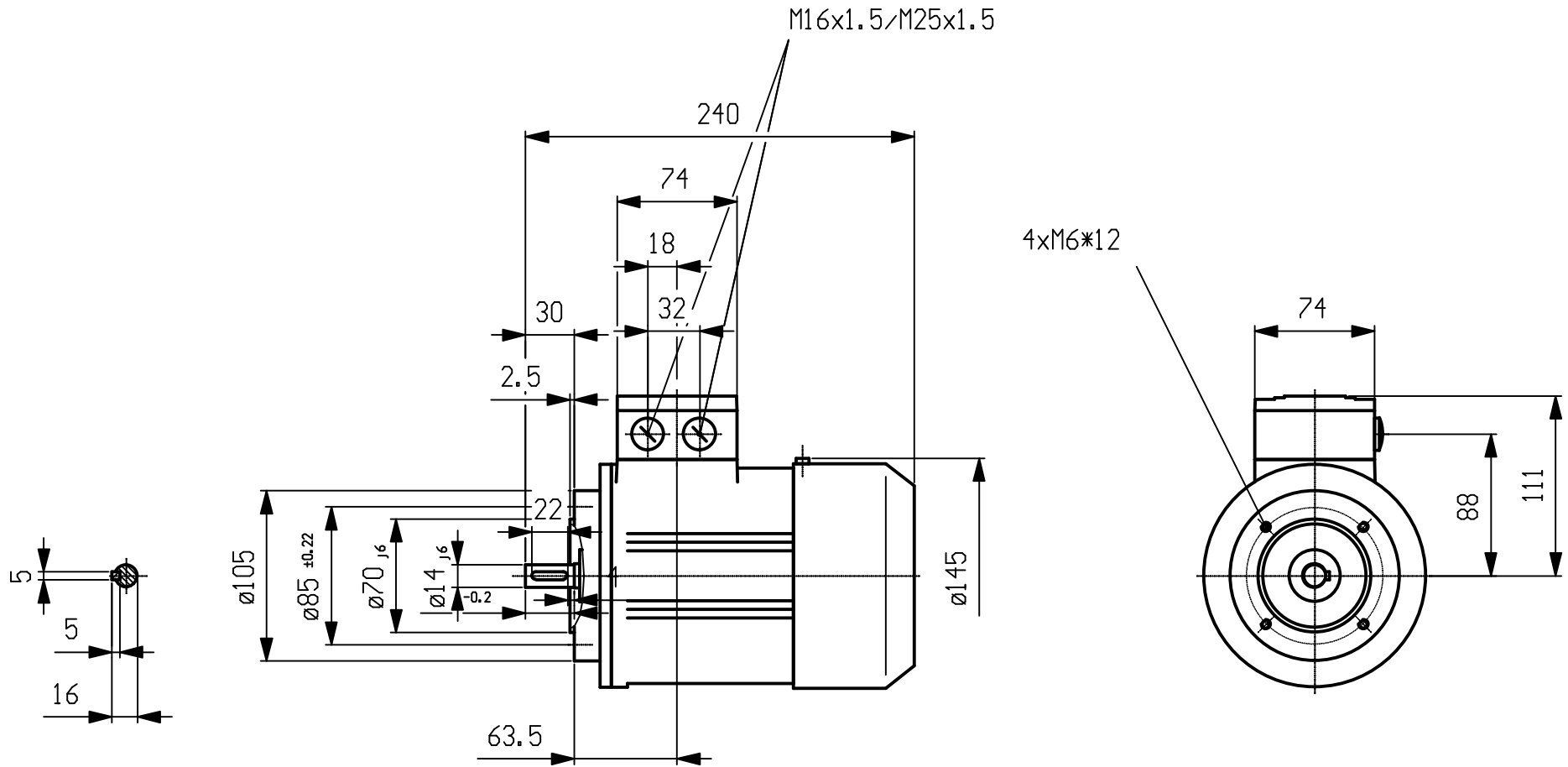

Massbild unverbindlich. Änderungen konstruktiver Einzelheiten vorbehalten.
 Dimension drawing subject to change. We reserve the right to change constructional details.



DIN 332-DR M5
 DIN 6885 Bl.1

	Angebot-Nr.: Offer No.:
	Anlage: Projekt:
A&D SD	1LA7070-8AB12
Datum/Date: 17.06.2009	
Einheit / unit: mm	
SIEMENS	