

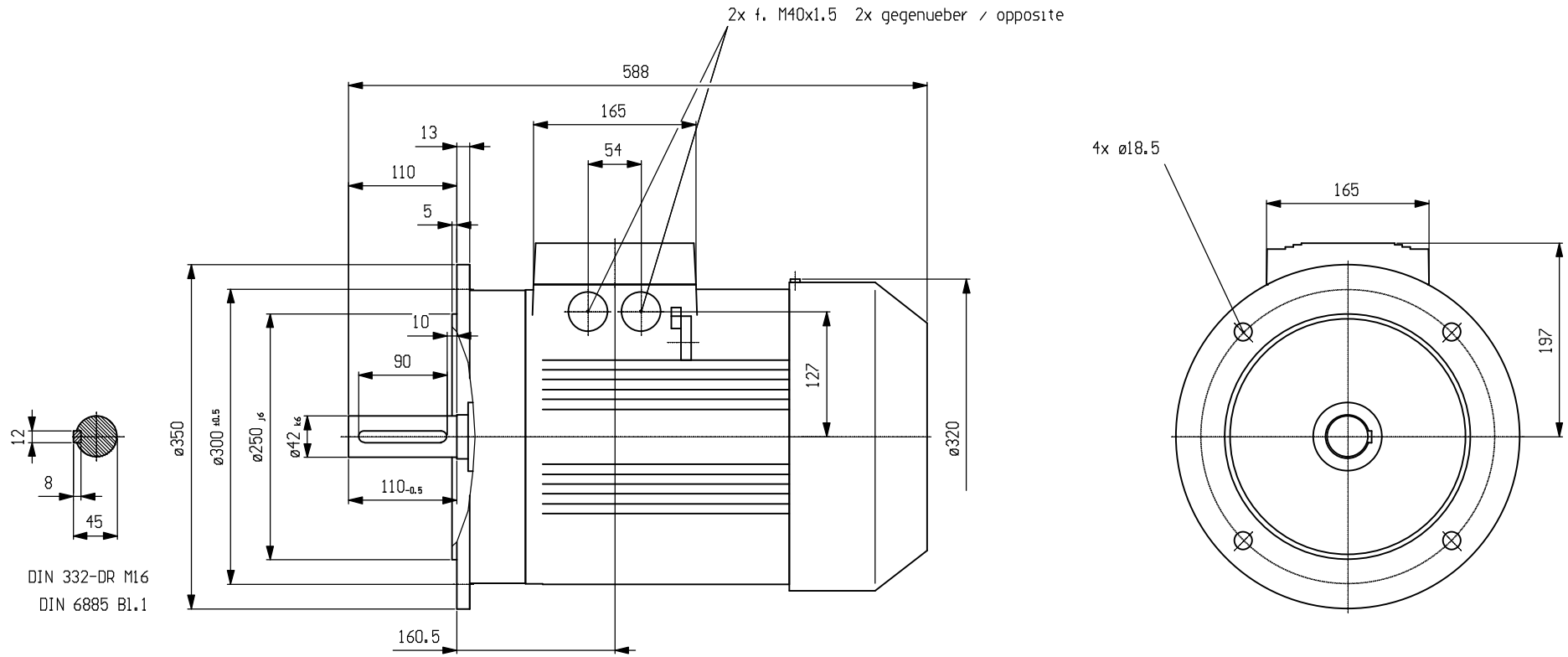

Massbild unverbindlich. Änderungen konstruktiver Einzelheiten vorbehalten.  
 Dimension drawing subject to change. We reserve the right to change constructional details.



	Angebot-Nr.:
	Offer No.:
A&D SD	Anlage:
Datum/Date: 21.10.2009	Projekt:
Einheit / unit: mm	1LA7166-2AA61
