

INFORMACE O VÝROBKU



PBT - klínové řemenice pro TaperLock®

PT - klínové řemenice polotovár

Použití:

Tyto řemenice jsou vhodné pro následující klínové řemeny:

XPZ - SPZ- Z-3V
XPB - SPB-B-5V
XPA - SPA-A
XPC - SPC-C

Materiál / technické informace:

PBT a PT klínové řemenice jsou vyrobeny z litiny, kvalita dle DIN1691 GG20-GG25.

Charakteristika:

Rozměry řemenic jsou velice přesné, protože všechny řemenice jsou vyráběny na CNC strojích nebo automatických soustružích. Řemenice PBT mohou být používány pro obvodovou rychlost 35 m/s, řemenice PT až po statickém vyvážení.

Povrchová úprava:

Řemenice jsou černě fosfátovány.

Vyváženost:

PBT klínové řemenice jsou staticky vyvážené.
PT nejsou staticky vyváženy.

Tolerance (viz. tabulka níže):

- ⊖ Tolerance výpočtového průměru řemenice dw
- ◇ Tolerance obvodového házení
- ◇ Tolerance čelního házení na výpočtovém průměru dw
- Maximální odchylka výpočtového průměru drážky vícedrážkové řemenice
-0,4 mm pro SPZ - SPA - SPB
-0,6 mm pro SPC

dw [mm]	50	56	63	71	80	90	100	112	118	125	132	140	150	160	180	190	200	212	
⊖ [mm]	+	0.4	0.4	0.5	0.6	0.6	0.7	0.8	0.9	1.0	1.0	1.0	1.1	1.2	1.3	1.4	1.5	1.6	1.7
	-	0.4	0.4	0.5	0.6	0.6	0.7	0.8	0.9	1.0	1.0	1.0	1.1	1.2	1.3	1.4	1.5	1.6	1.7
◇ [mm]	0.2						0.3						0.4						

dw [mm]	224	236	250	280	300	315	355	400	450	500	560	630	710	800	900	1000	1120	1250	
⊖ [mm]	+	1.8	1.9	2.0	2.2	2.4	2.5	2.8	3.2	3.6	4.0	4.5	5.0	5.7	6.4	7.2	8.0	9.0	10.0
	-	1.8	1.9	2.0	2.2	2.4	2.5	2.8	3.2	3.6	4.0	4.5	5.0	5.7	6.4	7.2	8.0	9.0	10.0
◇ [mm]	0.4			0.5				0.6				0.8				1			



Klínové řemenice

Rozměry drážky:

Dle DIN 2211

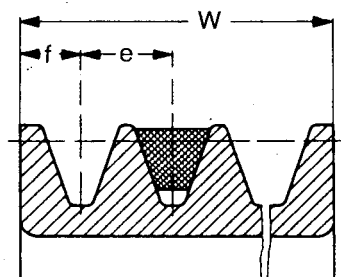
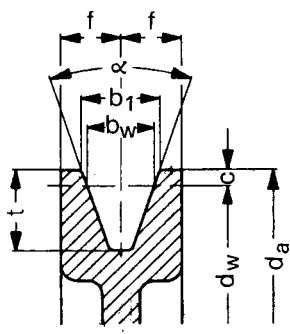

Profil řemenice		SPZ [mm]	SPA [mm]	SPB [mm]	C/SPC [mm]
b_w [mm]		8.5	11	14	19
b_1 [mm]		9.7	12.7	16.3	22
c [mm]		2	2.8	3.5	4.8
e [mm]		12 ± 0.3	15 ± 0.3	19 ± 0.4	25.5 ± 0.5
f [mm]		8 ± 0.6	10 ± 0.6	12.5 ± 0.6	17 ± 1
t [mm]	min.	$11^{+0.6}_0$	$13.8^{+0.6}_0$	$17.5^{+0.6}_0$	C:20 SPC $23.8^{+0.6}_0$
α	34° ————— pro d_w [mm] 38°	≤ 80	≤ 118	≤ 190	≤ 315
		> 80	> 118	> 190	> 315
Tolerance		$\pm 1^\circ$	$\pm 1^\circ$	$\pm 1^\circ$	$\pm 1^\circ$
W Šířka věnce řemenice závisící na počtu drážek Z	Z= 1	16	20	25	34
	2	28	35	44	59.5
	3	40	50	63	85
	4	52	65	82	110.5
	5	64	80	101	136
	6	76	95	120	161.5
	7	88	110	139	187
	8	100	125	158	212.5
	9	112	140	177	238
	10	124	155	196	263.5
	11	136	170	215	289
	12	148	185	234	314.5
Tolerance $d_i: (Z-1) \cdot e$ [mm]		± 0.6	± 0.6	± 0.8	± 1.0

PBT - klínové řemenice pro TaperLock®

Schéματα jednotlivých provedení:

<p>Provedení 1</p>	<p>Provedení 2</p>	<p>Provedení 3</p>	<p>Provedení 4</p>
<p>Provedení 5</p>	<p>Provedení 6</p>	<p>Provedení 7</p>	<p>Provedení 8</p>
<p>Provedení 9</p>	<p>Provedení 10</p>	<p>Provedení 11</p>	<p>Provedení 12</p>
<p>Provedení 13</p>	<p>Provedení 14</p>		

Klínové řemenice PBT

pro TaperLock®

Materiál

Šedá litina



SPZ-Z-3V

Obj. číslo	Výpočtový Ø dw	Počet drážek	Pouzdro TaperLock®	Otvor min./max.	Prove- dení	M	L	Z	U	kg
F 02125	63	1	1108	11-28	1	58	21	5	-	0.27
F 02126	63	2	1108	11-28	10	-	21	7	38	0.32
F 02120	63	3	1108	11-28	10	-	21	19	38	0.45
F 02127	67	1	1108	11-28	1	58	21	5	-	0.30
F 02128	67	2	1108	11-28	10	-	21	7	40	0.39
F 02129	67	3	1108	11-28	10	-	21	19	40	0.53
F 02130	71	1	1108	11-28	1	58	21	5	-	0.35
F 02131	71	2	1108	11-28	10	-	21	7	44	0.47
F 02132	71	3	1108	11-28	10	-	21	19	44	0.64
F 02133	75	1	1108	11-28	1	58	21	5	-	0.40
F 02134	75	2	1210	12-32	10	-	26	2	48	0.47
F 01892	75	3	1210	12-32	10	-	26	14	48	0.64
F 01848	75	4	1210	12-32	10	-	26	26	48	0.80
F 02013	80	1	1210	12-32	1	75	26	10	-	0.48
F 02135	80	2	1210	12-32	10	-	26	2	53	0.54
F 02136	80	3	1210	12-32	10	-	26	14	53	0.77
F 02137	80	4	1210	12-32	10	-	26	26	53	0.94
F 02138	85	1	1210	12-32	1	80	26	10	-	0.54
F 02139	85	2	1610	12-42	10	-	26	2	58	0.54
F 02140	85	3	1610	12-42	10	-	26	14	58	0.77
F 02141	85	4	1610	12-42	10	-	26	26	58	0.97
F 02142	85	5	1610	12-42	10	-	26	38	58	1.08
F 02143	90	1	1210	12-32	1	80	26	10	-	0.62
F 02144	90	2	1610	12-42	10	-	26	2	63	0.68
F 02145	90	3	1610	12-42	10	-	26	14	63	0.86
F 02146	90	4	1610	12-42	10	-	26	26	63	1.10
F 02147	90	5	1610	12-42	10	-	26	38	63	1.26
F 02148	95	1	1210	12-32	1	80	26	10	-	0.71
F 02149	95	2	1610	12-42	10	-	26	2	68	1.11
F 02150	95	3	1610	12-42	10	-	26	14	68	1.18
F 02151	95	4	1610	12-42	10	-	26	26	68	1.22
F 02152	95	5	1610	12-42	10	-	26	38	68	1.54
F 02153	100	1	1210	12-32	1	80	26	10	-	0.90
F 02154	100	2	1610	12-42	10	-	26	2	73	0.94
F 02155	100	3	1610	12-42	10	-	26	14	73	1.40
F 02156	100	4	1610	12-42	10	-	26	26	73	1.40
F 02157	100	5	2012	15-50	10	-	31	33	73	1.47
F 02158	106	1	1210	12-32	1	80	26	10	-	0.96
F 02159	106	2	1610	12-42	2	-	26	2	78	1.10
F 02160	106	3	1615	12-42	1	82	41	1	-	1.67
F 02161	106	4	2012	15-50	10	-	31	21	78	1.46
F 02162	106	5	2012	15-50	10	-	31	33	78	1.66

Rozměry uvedeny v mm.

Klínové řemenice PBT

pro TaperLock®

Materiál

Šedá litina



SPZ-Z-3V

Obj. číslo	Výpočtový Ø dw	Počet drážek	Pouzdro TaperLock®	Otvor min./max.	Prove- dení	M	L	Z	U	kg
F 02163	112	1	1610	12-42	1	80	26	10	-	0.98
F 02114	112	2	1610	12-42	10	-	26	2	85	1.32
F 02164	112	3	2012	15-50	10	-	31	9	85	1.64
F 02165	112	4	2012	15-50	10	-	31	21	85	1.70
F 02166	112	5	2012	15-50	10	-	31	33	85	1.97
F 02167	118	1	1610	12-42	1	80	26	10	-	1.24
F 02168	118	2	1610	12-42	2	-	26	2	93	1.47
F 02169	118	3	2012	15-50	10	-	31	9	93	1.92
F 02170	118	4	2012	15-50	2	-	31	21	93	1.98
F 02171	118	5	2012	15-50	2	-	31	33	93	2.14
F 02172	125	1	1610	12-42	1	88	26	10	-	1.28
F 02173	125	2	1610	12-42	10	-	26	2	98	1.70
F 02174	125	3	2012	15-50	2	-	31	9	98	1.98
F 02175	125	4	2012	15-50	2	-	31	21	98	2.28
F 02176	125	5	2012	15-50	10	-	31	33	98	2.57
F 02177	132	1	1610	12-42	4	90	26	10	105	1.30
F 02178	132	2	1610	12-42	5	90	26	2	105	1.80
F 02179	132	3	2012	15-50	2	-	31	9	105	2.24
F 02180	132	4	2012	15-50	2	-	31	21	105	2.60
F 02181	132	5	2517	18-60	2	-	46	18	105	2.86
F 02182	140	1	1610	12-42	4	90	26	10	113	1.38
F 02183	140	2	1610	12-42	5	90	26	2	113	1.80
F 02184	140	3	2012	15-50	2	-	31	9	113	2.68
F 02185	140	4	2012	15-50	2	-	31	21	113	2.98
F 02186	140	5	2517	18-60	2	-	46	18	113	3.40
F 02187	150	1	1610	12-42	4	90	26	10	123	1.52
F 02188	150	2	2012	15-50	4	110	31	3	123	2.49
F 02189	150	3	2012	15-50	5	110	31	9	123	2.84
F 02190	150	4	2517	18-60	2	-	46	6	123	3.76
F 02191	150	5	2517	18-60	2	-	46	18	123	4.14
F 02192	160	1	1610	12-42	4	90	26	10	133	1.65
F 02193	160	2	2012	15-50	4	110	31	3	133	2.42
F 02008	160	3	2012	15-50	5	110	31	9	133	2.92
F 02194	160	4	2517	18-60	5	120	46	6	133	4.20
F 02195	160	5	2517	18-60	5	120	46	18	133	4.40
F 02196	180	1	1610	12-42	4	90	26	10	153	1.72
F 02197	180	2	2012	15-50	4	110	31	3	153	2.80
F 02198	180	3	2012	15-50	5	110	31	9	153	3.42
F 02199	180	4	2517	18-60	5	120	46	6	153	4.10
F 02200	180	5	2517	18-60	5	120	46	18	153	4.78
F 02201	200	1	2012	15-50	4	110	31	15	173	2.51
F 02202	200	2	2012	15-50	4	110	31	3	173	3.27
F 02203	200	3	2012	15-50	6	110	31	4.5	173	3.93
F 02204	200	4	2517	18-60	6	120	46	3	173	4.82
F 02205	200	5	2517	18-60	6	120	46	9	173	5.20

Rozměry uvedeny v mm.

Klínové řemenice PBT pro TaperLock®

Materiál

Šedá litina



SPZ-Z-3V

Obj. číslo	Výpočtový Ø dw	Počet drážek	Pouzdro TaperLock®	Otvor min./max.	Prove- dení	M	L	Z	U	kg
F 02206	224	1	2012	15-50	3	110	31	7.5	197	2.78
F 02207	224	2	2012	15-50	4	110	31	3	197	3.80
F 02208	224	3	2012	15-50	5	110	31	9	197	4.60
F 02209	224	4	2517	18-60	5	120	46	6	197	5.56
F 02210	224	5	2517	18-60	5	120	46	18	197	5.90
F 02211	250	1	2012	15-50	3	110	31	7.5	223	3.61
F 02212	250	2	2012	15-50	3	110	31	1.5	223	3.70
F 02213	250	3	2012	15-50	6	110	31	4.5	223	4.82
F 02214	250	4	2517	18-60	6	120	46	3	223	5.96
F 02215	250	5	2517	18-60	6	120	46	9	223	7.00
F 02216	280	1	2012	15-50	3	110	31	7.5	253	3.18
F 02217	280	2	2012	15-50	7	110	31	3	253	4.20
F 02218	280	3	2517	18-65	7	120	46	6	253	6.66
F 02219	280	4	2517	18-60	8	120	46	6	253	7.30
F 02220	280	5	2517	18-60	8	120	46	18	253	8.84
F 02221	315	1	2012	15-50	3	110	31	7.5	288	3.56
F 02009	315	2	2012	15-50	3	110	31	1.5	288	4.85
F 02222	315	3	2517	18-60	3	120	46	3	288	6.34
F 02223	315	4	2517	18-60	9	120	46	3	288	7.36
F 02224	315	5	2517	18-60	9	120	46	9	288	8.26
F 02225	355	1	2012	15-50	7	110	31	15	328	5.46
F 02226	355	2	2012	15-50	7	110	31	3	328	5.96
F 02227	355	3	2517	18-60	7	120	46	6	328	9.32
F 02228	355	4	2517	18-60	8	120	46	6	328	8.10
F 02229	355	5	2517	18-60	8	120	46	18	328	14.06
F 02230	400	1	2012	15-50	3	110	31	7.5	373	5.52
F 02231	400	2	2517	18-60	3	120	46	9	373	7.41
F 02232	400	3	2517	18-60	3	120	46	3	373	9.81
F 02233	400	4	2517	18-60	9	120	46	3	373	10.31
F 02234	400	5	3020	25-75	9	146	51	6.5	373	12.62
F 02235	450	1	2517	18-60	7	120	46	30	423	6.20
F 02236	450	2	2517	18-60	7	120	46	18	423	8.00
F 02237	450	3	2517	18-60	7	120	46	6	423	11.30
F 02238	450	4	3020	25-75	8	146	51	1	423	16.73
F 02239	450	5	3020	25-75	8	146	51	13	423	17.66
F 02240	500	1	2517	18-60	7	120	46	30	473	8.84
F 02241	500	2	2517	18-60	3	120	46	9	473	10.66
F 01891	500	3	2517	18-60	3	120	46	3	473	13.82
F 02242	500	4	3020	25-75	9	146	51	1	473	16.58
F 02243	500	5	3020	25-75	9	146	51	6.5	473	17.26
F 02244	630	1	2517	18-60	7	120	46	30	603	15.60
F 02245	630	2	2517	18-60	7	120	46	18	603	18.90
F 02246	630	3	2517	18-60	3	120	46	3	603	24.50
F 02247	630	4	3020	25-75	9	146	51	1	603	29.38
F 02248	630	5	3020	25-75	9	146	51	6.5	603	30.60

Rozměry uvedeny v mm.

Klínové řemenice PBT pro TaperLock®

Materiál

Šedá litina

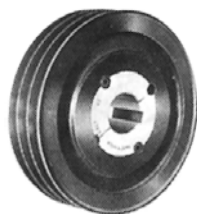

SPA-A

Obj. číslo	Výpočtový Ø dw	Počet drážek	Pouzdro TaperLock®	Otvor min./max.	Prove- dení	M	L	Z	U	kg
F 01716	71	1	1108	11-28	1	60	22	2	-	0.30
F 02249	71	2	1108	11-28	10	-	22	13	40	0.50
F 02250	71	3	1108	11-28	10	-	22	28	40	0.70
F 01717	75	1	1108	11-28	1	60	22	2	-	0.40
F 02251	75	2	1108	11-28	10	-	22	13	44	0.60
F 02252	75	3	1108	11-28	10	-	22	28	44	0.80
F 01718	80	1	1210	12-32	1	84	25	5	-	0.50
F 01733	80	2	1210	12-32	10	-	25	10	50	0.60
F 01757	80	3	1210	12-32	10	-	25	25	50	0.90
F 01719	85	1	1210	12-32	1	88	25	5	-	0.60
F 01734	85	2	1210	12-32	10	-	25	10	55	0.70
F 02253	85	3	1210	12-32	10	-	25	25	55	1.00
F 01720	90	1	1210	12-32	1	80	26	6	-	0.73
F 01735	90	2	1610	12-42	10	-	26	9	57	0.90
F 01758	90	3	1610	12-42	10	-	26	24	57	1.04
F 01948	90	4	1610	12-42	11	-	26	19.5	57	1.21
F 01721	95	1	1210	12-32	1	80	26	6	-	0.78
F 01736	95	2	1610	12-42	10	-	26	9	63	1.10
F 01759	95	3	1610	12-42	10	-	26	24	63	1.26
F 01783	95	4	1610	12-42	11	-	26	19.5	63	1.58
F 01722	100	1	1610	12-42	1	90	26	6	-	0.84
F 01737	100	2	1610	12-42	10	-	26	9	68	1.20
F 01760	100	3	1610	12-42	2	-	26	24	68	1.40
F 01784	100	4	1610	12-42	2	-	26	39	68	1.70
F 02254	100	5	1610	12-42	11	-	26	27	68	2.04
F 01723	106	1	1610	12-42	1	90	26	6	-	0.98
F 01738	106	2	1610	12-42	10	-	26	9	73	1.25
F 01763	106	3	1610	12-42	2	-	26	24	73	1.59
F 01875	106	4	2012	15-50	10	-	31	34	73	1.74
F 02255	106	5	2012	15-50	10	-	31	49	73	2.13
F 01724	112	1	1610	12-42	1	90	26	6	-	1.14
F 01739	112	2	1610	12-42	10	-	26	9	79	1.46
F 01764	112	3	2012	15-50	10	-	31	19	79	1.85
F 01785	112	4	2012	15-50	10	-	31	34	79	2.02
F 02256	112	5	2012	15-50	10	-	31	49	79	2.38
F 01725	118	1	1610	12-42	1	90	26	6	-	1.26
F 01740	118	2	1610	12-42	10	-	26	9	85	1.68
F 01765	118	3	2012	15-50	2	-	31	19	85	1.92
F 02257	118	4	2012	15-50	2	-	31	34	85	2.29
F 02258	118	5	2012	15-50	2	-	31	49	85	2.67
F 01726	125	1	1610	12-42	1	90	26	6	-	1.45
F 01742	125	2	1610	12-42	10	-	26	9	92	1.93
F 01766	125	3	2012	15-50	2	-	31	19	92	2.28
F 01922	125	4	2012	15-50	2	-	31	34	92	2.70
F 02259	125	5	2012	15-50	11	-	31	24.5	92	3.10

Rozměry uvedeny v mm.

Klínové řemenice PBT pro TaperLock®

Materiál

Šedá litina

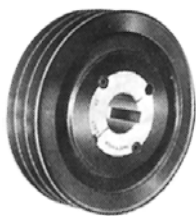

SPA-A

Obj. číslo	Výpočtový Ø dw	Počet drážek	Pouzdro TaperLock®	Otvor min./max.	Prove- dení	M	L	Z	U	 kg
F 01727	132	1	1610	12-42	1	90	26	6	-	1.64
F 01743	132	2	2012	15-50	10	-	31	4	99	2.08
F 01767	132	3	2012	15-50	2	-	31	19	99	2.62
F 01786	132	4	2517	18-60	2	-	46	19	99	3.10
F 02260	132	5	2517	18-60	11	-	46	17	99	3.40
F 01728	140	1	1610	12-42	4	90	26	6	107	1.66
F 01744	140	2	2012	15-50	2	-	31	4	107	2.50
F 01768	140	3	2517	18-60	10	-	46	4	107	3.04
F 01787	140	4	2517	18-60	2	-	46	19	107	3.53
F 02261	140	5	2517	18-60	11	-	46	17	107	4.20
F 01729	150	1	1610	12-42	4	90	26	6	117	1.73
F 01745	150	2	2012	15-50	2	-	31	4	117	2.96
F 01769	150	3	2517	18-60	10	-	46	4	117	3.75
F 01788	150	4	2517	18-60	2	-	46	19	117	4.30
F 02262	150	5	2517	18-60	11	-	46	17	117	4.90
F 01730	160	1	1610	12-42	4	90	26	6	127	2.02
F 01746	160	2	2012	15-50	5	110	31	4	127	3.28
F 01774	160	3	2517	18-60	10	-	46	4	127	4.55
F 01805	160	4	2517	18-60	2	-	46	19	127	5.08
F 02121	160	5	2517	18-60	11	-	46	17	127	5.57
F 01731	170	1	1610	12-42	4	90	26	6	137	2.06
F 01747	170	2	2012	15-50	5	110	31	4	137	3.30
F 01775	170	3	2517	18-60	5	120	46	4	137	5.29
F 02263	170	4	2517	18-60	5	120	46	19	137	5.90
F 02264	170	5	2517	18-60	6	120	46	17	137	6.60
F 01732	180	1	1610	12-42	4	90	26	6	147	2.27
F 01748	180	2	2012	15-50	5	110	31	4	147	3.20
F 01776	180	3	2517	18-60	5	120	46	4	147	4.90
F 01806	180	4	2517	18-60	5	120	46	19	147	5.70
F 02265	180	5	3020	25-75	11	-	51	14.5	147	6.78
F 01824	190	1	2012	15-50	4	110	31	11	157	2.61
F 01749	190	2	2012	15-50	5	110	31	4	157	3.48
F 01777	190	3	2517	18-60	5	120	46	4	157	4.82
F 02266	190	4	2517	18-60	5	120	46	19	157	5.68
F 02267	190	5	3020	25-75	11	-	51	14.5	157	7.93
F 01825	200	1	2012	15-50	4	110	31	11	167	3.16
F 01750	200	2	2517	18-60	4	120	46	11	167	4.70
F 01778	200	3	2517	18-60	5	120	46	4	167	5.36
F 01807	200	4	3020	25-75	5	146	51	14	167	8.20
F 02268	200	5	3020	25-75	6	146	51	14.5	167	8.40
F 01965	224	1	2012	15-50	4	110	31	11	191	3.42
F 01751	224	2	2517	18-60	4	120	46	11	191	5.68
F 01779	224	3	2517	18-60	6	120	46	2	191	5.90
F 01808	224	4	3020	25-75	5	146	51	14	191	8.20
F 02269	224	5	3020	25-75	5	146	51	29	191	9.06
F 01973	236	1	2012	15-50	4	110	31	11	203	3.64
F 01826	236	2	2517	18-60	4	120	46	11	203	5.09
F 01828	236	3	2517	18-60	5	120	46	4	203	6.30
F 01809	236	4	3020	25-75	6	146	51	7	203	8.24
F 02270	236	5	3020	25-75	6	146	51	14.5	203	9.46

Rozměry uvedeny v mm.

Klínové řemenice PBT

pro TaperLock®

Materiál

Šedá litina



SPA-A

Obj. číslo	Výpočtový Ø dw	Počet drážek	Pouzdro TaperLock®	Otvor min./max.	Prove- dení	M	L	Z	U	kg
F 02062	250	1	2012	15-50	4	110	31	11	217	4.14
F 01827	250	2	2517	18-60	4	120	46	11	217	6.03
F 01780	250	3	2517	18-60	6	120	46	2	217	7.92
F 01810	250	4	3020	25-75	6	146	51	7	217	8.28
F 02271	250	5	3020	25-75	9	146	51	14.5	217	10.15
F 02272	280	1	2012	15-50	7	110	31	11	247	4.40
F 01940	280	2	2517	18-60	7	120	46	11	247	6.70
F 01781	280	3	2517	18-60	6	120	46	2	247	7.90
F 01812	280	4	3020	25-75	6	146	51	7	247	11.15
F 02273	280	5	3020	25-75	9	146	51	14.5	247	11.20
F 02274	315	1	2012	15-50	7	110	31	11	282	4.40
F 01831	315	2	2517	18-60	7	120	46	11	282	6.56
F 01782	315	3	3020	25-75	3	146	51	0.5	282	8.56
F 02275	315	4	3020	25-75	9	146	51	7	282	9.64
F 02276	315	5	3020	25-75	9	146	51	14.5	282	13.00
F 02277	355	1	2012	15-50	7	110	31	11	322	5.50
F 01895	355	2	2517	18-60	7	120	46	11	322	7.97
F 02278	355	3	3020	25-75'	3	146	51	0.5	322	10.40
F 01874	355	4	3020	25-75	9	146	51	7	322	14.44
F 02279	355	5	3020	25-75	9	146	51	14.5	322	15.66
F 02280	400	1	2012	15-50	7	110	31	11	367	6.72
F 02281	400	2	2517	18-60	7	120	46	11	367	9.08
F 02282	400	3	3020	25-75	3	146	51	0.5	367	12.28
F 02283	400	4	3020	25-75	9	146	51	7	367	15.40
F 02284	400	5	3020	25-75	9	146	51	14.5	367	17.02
F 02061	450	1	2517	18-60	7	120	46	26	417	8.20
F 02285	450	2	2517	18-60	7	120	46	11	417	10.52
F 02286	450	3	3020	25-75	3	146	51	0.5	417	13.42
F 02287	450	4	3020	25-75	9	146	51	7	417	16.82
F 02288	450	5	3020	25-75	9	146	51	14.5	417	20.50
F 02289	500	1	2517	18-60	7	120	46	26	467	10.48
F 02290	500	2	2517	18-60	7	120	46	11	467	12.90
F 01855	500	3	3020	25-75	3	146	51	0.5	467	16.90
F 02291	500	4	3020	25-75	9	146	51	7	467	19.80
F 02292	500	5	3020	25-75	9	146	91	14.5	467	23.10
F 02293	560	1	3020	25-75	7	146	51	31	527	14.80
F 02294	560	2	3020	25-75	7	146	51	16	527	19.00
F 02295	560	3	3020	25-75	7	146	51	1	527	23.94
F 02296	560	4	3020	25-75	8	146	51	14	527	32.00
F 02297	560	5	3525	45-90	7	178	91	11	527	40.00
F 02298	630	3	3020	25-75	7	146	51	31	597	17.00
F 02299	630	4	3020	25-75	7	146	51	16	597	21.52
F 02300	630	4	3020	25-75	7	146	51	1	597	25.78
F 02301	630	4	3020	25-75	8	146	51	14	597	32.78
F 02302	630	5	3525	45-90	7	178	91	11	597	44.60
F 02303	800	3	3535	45-90	7	178	91	41	767	41.00
F 01832	800	4	3535	45-90	7	178	91	26	767	50.00
F 02304	800	5	3535	45-90	7	178	91	11	767	52.50
F 02305	1000	3	3525	45-90	7	178	91	41	967	50.00
F 02306	1000	4	4040	55-100	7	215	101	36	967	68.00
F 02307	1000	5	4040	55-100	7	215	101	21	967	74.00

Rozměry uvedeny v mm.

Klínové řemenice PBT

pro TaperLock®

Materiál

Šedá litina

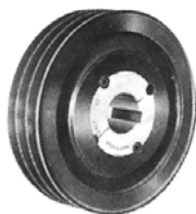

SPB-B-5V

Obj. číslo	Výpočtový Ø dw	Počet drážek	Pouzdro TaperLock®	Otvor min./max.	Prove- dení	M	L	Z	U	Ø _h kg
F 02308	90	1	1210	15-50	1	-	25	-	-	0.75
F 02309	90	2	1210	15-50	10	-	25	19	47	1.15
F 02310	90	3	1210	15-50	10	-	25	28	47	1.55
F 02311	100	1	1610	12-42	2	-	25	-	-	0.91
F 02312	100	2	1610	12-42	10	-	25	19	60	1.25
F 02313	100	3	1610	12-42	10	-	25	28	57	1.95
F 02314	112	1	1610	12-42	2	-	25	-	-	1.15
F 02315	112	2	1610	12-42	10	-	25	19	69	1.68
F 02316	112	3	1610	12-42	10	-	25	28	69	2.25
F 02317	118	1	1610	12-42	2	-	25	-	-	1.45
F 02318	118	2	1610	12-42	10	-	25	19	76	2.00
F 01907	118	3	1610	12-42	10	-	25	28	76	2.60
F 02319	125	1	1610	12-42	2	-	25	-	-	1.70
F 02320	125	2	2012	15-50	2	-	32	12	86	2.10
F 02321	125	3	2012	15-50	2	-	32	31	86	2.44
F 02322	125	4	2012	15-50	11	-	32	50/25	86	2.94
F 02323	132	1	1610	12-42	2	-	25	-	-	2.10
F 02056	132	2	2012	15-50	2	-	32	12	89	2.37
F 01799	132	3	2012	15-50	2	-	32	31	89	3.08
F 02324	132	4	2012	15-50	11	-	32	50/25	89	3.90
F 02325	140	1	1610	12-42	1	-	25	-	-	2.06
F 02326	140	2	2012	15-50	2	-	31	13	100	2.70
F 01877	140	3	2012	15-50	2	-	31	32	100	3.40
F 02080	140	4	2517	18-60	11	-	46	18	100	3.80
F 02327	140	5	2517	18-60	11	-	46	27.5	100	4.50
F 02328	140	6	2517	18-60	11	-	46	37	100	5.40
F 02329	150	1	1610	12-42	1	-	25	-	-	2.45
F 01935	150	2	2012	15-50	2	-	31	13	110	3.30
F 01800	150	3	2517	18-60	2	-	46	17	110	4.01
F 02330	150	4	2517	18-60	11	-	46	18	110	4.86
F 02331	150	5	2517	18-60	11	-	46	27.5	110	5.50
F 02332	150	6	2517	18-60	11	-	46	37	110	6.24
F 02333	160	1	1610	12-42	1	-	25	-	-	2.87
F 02334	160	2	2012	15-50	2	-	31	13	120	3.86
F 01813	160	3	2517	18-60	2	-	46	17	120	4.96
F 01915	160	4	2517	18-60	11	-	46	18	120	5.72
F 02335	160	5	2517	18-60	11	-	46	27.5	120	6.39
F 02336	160	6	3020	25-75	11	-	51	34.5	120	7.22
F 02337	160	8	3020	25-75	11	-	51	53.5	120	7.92
F 01794	170	1	1610	12-42	1	-	25	-	-	3.31
F 02338	170	2	2012	15-50	2	-	31	13	130	4.46
F 01801	170	3	2517	18-60	2	-	46	17	130	5.76
F 02339	170	4	2517	18-60	11	-	46	18	130	6.80
F 02340	170	5	3020	25-75	11	-	51	25	130	6.60
F 02341	170	6	3020	25-75	11	-	51	34.5	130	7.64
F 02342	170	8	3020	25-75	11	-	51	53.5	130	9.18

Rozměry uvedeny v mm.

Klínové řemenice PBT

pro TaperLock®

Materiál

Šedá litina

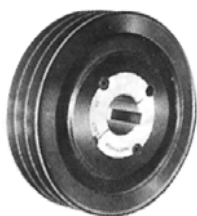

SPB-B-5V

Obj. číslo	Výpočtový Ø dw	Počet drážek	Pouzdro TaperLock®	Otvor min./max.	Prove- dení	M	L	Z	U	kg
F 01795	180	1	1610	12-42	1	-	25	-	-	3.98
F 01798	180	2	2517	18-60	4	120	46	2	140	4.86
F 01814	180	3	2517	18-60	5	120	46	17	140	5.86
F 01930	180	4	2517	18-60	6	120	46	18	140	7.66
F 02343	180	5	3020	25-75	11	-	51	25	140	7.80
F 02344	180	6	3020	25-75	11	-	51	34.5	140	8.52
F 02345	180	8	3020	25-75	11	-	51	53.5	140	9.94
F 02346	190	1	2012	15-50	4	112	32	7	-	4.10
F 02347	190	2	2517	18-60	4	120	46	2	150	4.92
F 01802	190	3	2517	18-60	5	120	46	17	150	5.96
F 01821	190	4	2517	18-60	6	120	46	18	150	8.68
F 02348	190	5	3020	25-75	11	-	51	25	150	9.00
F 02349	190	6	3020	25-75	11	-	51	34.5	150	9.80
F 02350	190	8	3020	25-75	11	-	51	53.5	.50	13.50
F 01796	200	1	2012	15-50	4	112	32	7	-	4.10
F 02351	200	2	2517	18-60	4	120	46	2	160	5.30
F 01815	200	3	2517	18-60	5	120	46	17	160	6.35
F 01822	200	4	3020	25-75	6	146	51	15.5	160	9.45
F 02352	200	5	3020	25-75	6	146	51	25	160	10.52
F 02353	200	6	3020	25-75	6	146	51	34.5	160	11.00
F 02354	200	8	3535	45-90	11	-	91	33.5	160	15.28
F 01936	212	2	2517	18-60	4	120	46	2	172	5.84
F 01803	212	3	2517	18-60	5	120	46	17	172	6.90
F 02355	212	4	3020	25-75	6	146	51	15.5	172	9.56
F 02356	212	5	3020	25-75	6	146	51	25	172	10.52
F 02357	212	6	3535	45-90	11	-	91	14.5	172	15.55
F 02358	212	8	3535	45-90	11	-	91	33.5	172	17.90
F 02359	224	2	2517	18-60	4	120	46	2	184	5.94
F 01876	224	3	2517	18-60	5	120	46	17	184	7.38
F 02081	224	4	3020	25-75	6	146	51	15.5	184	9.56
F 02360	224	5	3020	25-75	6	146	51	25	184	12.38
F 02361	224	6	3535	45-90	11	-	91	14.5	184	17.00
F 02362	224	8	3535	45-90	11	-	91	33.5	184	20.62
F 01823	236	2	2517	18-60	4	120	46	2	196	6.90
F 01804	236	3	2517	18-60	6	120	46	8.5	196	7.81
F 02011	236	4	3020	25-75	6	146	51	15.5	196	10.00
F 02363	236	5	3535	45-90	11	178	91	5	196	19.30
F 01861	236	6	3535	45-90	11	178	91	14.5	196	20.12
F 02364	236	8	3535	45-90	11	178	91	33.5	196	23.82
F 02365	250	2	2517	18-60	4	120	46	2	210	6.90
F 01816	250	3	3020	25-75	5	146	51	12	210	9.04
F 02366	250	4	3020	25-75	6	146	51	15.5	210	11.10
F 02367	250	5	3535	45-90	6	178	91	5	210	19.63
F 02368	250	6	3535	45-90	6	178	91	14.5	210	21.00
F 02369	250	8	3535	45-90	6	178	91	33.5	210	24.62

Rozměry uvedeny v mm.

Klínové řemenice PBT pro TaperLock®

Materiál

Šedá litina

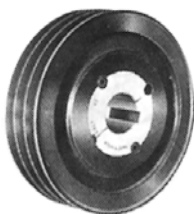

SPB-B-5V

Obj. číslo	Výpočtový Ø dw	Počet drážek	Pouzdro TaperLock®	Otvor min./max.	Prove- dení	M	L	Z	U	kg
F 02370	280	2	2517	18-60	4	120	46	2	240	8.46
F 01817	280	3	3020	25-75	6	146	51	6	240	11.00
F 02371	280	4	3020	25-75	6	146	51	15.5	240	12.76
F 02105	280	5	3535	45-90	6	178	91	5	240	19.63
F 02372	280	6	3535	45-90	6	178	91	14.5	240	22.12
F 02373	280	8	3535	45-90	6	178	91	33.5	240	24.86
F 02374	300	2	2517	18-60	4	120	46	2	260	9.19
F 01818	300	3	3020	25-75	5	146	51	12	260	14.94
F 02375	300	4	3535	45-90	4	178	91	9	260	21.16
F 02376	300	5	3535	45-90	5	178	91	10	260	24.10
F 02377	300	6	3535	45-90	5	178	91	29	260	27.44
F 02378	300	8	3535	45-90	6	178	91	33.5	260	25.24
F 02055	315	2	2517	18-60	12	120	46	2	275	9.76
F 01819	315	3	3020	25-75	6	146	51	6	275	12.34
F 02379	315	4	3535	45-90	4	178	91	9	275	19.82
F 02380	315	5	3535	45-90	5	178	91	10	275	21.52
F 02381	315	6	3535	45-90	6	178	91	14.5	275	24.60
F 02382	315	8	3535	45-90	6	178	91	33.5	275	28.52
F 02383	355	2	3020	25-75	3	146	51	3.5	315	10.37
F 02012	355	3	3020	25-75	9	146	51	6	315	13.10
F 01916	355	4	3535	45-90	7	178	91	9	315	20.48
F 02384	355	5	3535	45-90	8	178	91	10	315	24.20
F 02385	355	6	3535	45-90	8	178	91	29	315	27.00
F 02386	355	8	3535	45-90	9	178	91	33.5	315	32.02
F 02387	400	2	3020	25-75	3	146	51	35	360	11.50
F 01820	400	3	3535	45-90	7	178	91	28	360	19.64
F 01833	400	4	3535	45-90	7	178	91	9	360	22.24
F 02388	400	5	3535	45-90	8	178	91	10	360	25.61
F 02389	400	6	3535	45-90	8	178	91	29	360	28.30
F 02390	400	8	4040	55-100	9	267	101	28.5	360	34.70
F 02391	450	2	3020	25-75	7	146	51	7	410	14.50
F 02027	450	3	3535	45-90	7	178	91	28	410	22.94
F 02392	450	4	3535	45-90	7	178	91	9	410	25.70
F 02393	450	5	3535	45-90	8	178	91	10	410	29.00
F 02394	450	6	4040	55-100	8	215	101	9	410	37.80
F 02395	450	8	4040	55-100	9	215	101	28.5	410	41.35
F 02396	500	2	3020	25-75	3	146	51	3.5	460	16.28
F 02397	500	3	3535	45-90	7	178	91	28	460	24.00
F 02398	500	4	3535	45-90	7	178	91	9	460	29.00
F 02399	500	5	3535	45-90	8	178	91	10	460	33.80
F 02400	500	6	4040	55-100	8	215	101	19	460	41.50
F 02401	500	8	4040	55-100	9	215	101	28.5	460	48.00

Rozměry uvedeny v mm.

Klínové řemenice PBT pro TaperLock®

Materiál

Šedá litina



SPB-B-5V

Obj. číslo	Výpočtový Ø dw	Počet drážek	Pouzdro TaperLock®	Otvor min./max.	Prove- dení	M	L	Z	U	kg
F 02402	560	2	3020	25-75	7	146	51	7	520	24.72
F 01906	560	3	3535	45-90	7	178	91	28	520	33.70
F 02403	560	4	3535	45-90	7	178	91	9	520	40.62
F 02106	560	5	3535	45-90	8	178	91	10	520	48.50
F 02404	560	6	4040	55-100	8	215	101	19	520	57.00
F 02405	560	8	4040	55-100	9	215	101	28.5	520	71.20
F 02406	630	2	3535	45-90	7	178	91	47	590	27.00
F 02407	630	3	3535	45-90	7	178	91	28	590	33.04
F 02408	630	4	3535	45-90	7	178	91	9	590	41.50
F 02409	630	5	4040	55-100	8	215	101	-	590	53.00
F 02410	630	6	4040	55-100	8	215	101	19	590	62.00
F 02411	630	8	5050	70-125	9	267	126	16	590	90.00
F 02412	710	2	3535	45-90	7	178	91	47	670	32.00
F 02413	710	3	3535	45-90	7	178	91	28	670	39.20
F 02414	710	4	3535	45-90	7	178	91	9	670	57.00
F 02415	710	5	4040	55-100	8	215	101	-	670	62.00
F 02416	710	6	4040	55-100	8	215	101	19	670	63.00
F 02417	710	8	5050	70-125	9	267	126	16	670	91.00
F 02418	800	2	3535	45-90	7	178	91	47	760	50.50
F 02419	800	3	3535	45-90	7	178	91	28	760	47.00
F 02122	800	4	4040	55-100	7	215	101	19	760	68.00
F 02420	800	5	4040	55-100	8	215	101	-	760	75.50
F 02421	800	6	4040	55-100	8	215	101	19	760	93.00
F 02422	800	8	5050	70-125	9	267	126	16	760	98.00
F 02423	900	3	3535	45-90	7	178	91	28	860	79.00
F 02424	900	4	4040	55-100	7	215	101	19	860	83.00
F 02425	900	5	4040	55-100	8	215	101	-	860	85.00
F 02426	900	6	4040	55-100	8	215	101	19	860	100.00
F 02427	900	8	5050	70-125	9	267	126	16	860	118.00
F 02428	1000	3	4040	55-100	7	215	101	38	958	80.00
F 02429	1000	4	4040	55-100	7	215	101	19	958	83.00
F 02430	1000	5	4040	55-100	8	215	101	-	958	88.00
F 02431	1000	6	4040	55-100	8	215	101	19	958	115.00
F 02432	1000	8	5050	70-125	9	267	126	16	958	137.00
F 02433	1250	3	4040	55-100	7	215	101	38	1208	108.00
F 02434	1250	4	4040	55-100	7	215	101	19	1208	117.00
F 02435	1250	5	4040	55-100	8	215	101	-	1208	132.00
F 02436	1250	6	5050	70-125	7	267	126	6	1208	150.00
F 02437	1250	8	5050	70-125	9	267	126	16	1208	173.00

Rozměry uvedeny v mm.

Klínové řemenice PBT pro TaperLock®

Materiál

Šedá litina



SPC-C

Obj. číslo	Výpočtový Ø dw	Počet drážek	Pouzdro TaperLock®	Otvor min./max.	Prove- dení	M	L	Z	U	kg
F 02057	224	3	3020	25-75	11	-	51	17	166	12.00
F 02438	224	4	3020	25-75	11	-	51	29.75	166	15.00
F 02439	224	5	3535	45-90	11	-	91	22.5	166	19.50
F 02440	224	6	3535	45-90	11	-	91	35.25	166	24.00
F 02441	224	8	3535	45-90	13	-	91	43.5	166	26.32
F 02442	236	3	3020	25-75	11	-	51	17	178	14.00
F 02443	236	4	3535	45-90	11	-	91	9.75	178	19.50
F 02444	236	5	3535	45-90	11	-	91	22.5	178	21.74
F 02445	236	6	3535	45-90	11	-	91	35.25	178	24.38
F 02446	236	8	3535	45-90	13	-	91	43.5	178	29.64
F 02095	250	3	3020	25-75	6	146	51	17	192	15.00
F 02447	250	4	3535	45-90	11	-	91	9.75	192	24.00
F 02448	250	5	3535	45-90	11	-	91	22.5	192	25.60
F 02449	250	6	3535	45-90	11	-	91	35.25	192	28.58
F 02450	250	8	3535	45-90	11	-	91	60.75	192	33.80
F 02451	265	3	3020	25-75	6	146	51	17	207	15.00
F 02452	265	4	3535	45-90	6	178	91	9.75	207	26.00
F 02453	265	5	3535	45-90	6	178	91	22.5	207	38.36
F 02454	265	6	3535	45-90	6	178	91	35.25	207	31.70
F 02455	265	8	3535	45-90	6	178	91	60.75	207	37.66
F 02058	280	3	3020	25-75	6	146	51	17	222	16.00
F 02456	280	4	3535	45-90	6	178	91	9.75	222	31.00
F 02457	280	5	3535	45-90	6	178	91	22.5	222	31.00
F 02458	280	6	3535	45-90	6	178	91	35.25	222	33.00
F 02459	280	8	4040	55-100	11	-	101	55.75	222	41.60
F 02460	300	3	3535	45-90	14	178	91	3	242	25.00
F 02461	300	4	3535	45-90	6	178	91	9.75	242	32.00
F 02462	300	5	3535	45-90	6	178	91	22.5	242	32.00
F 02463	300	6	3535	45-90	6	178	91	35.25	242	33.30
F 02464	300	8	4040	55-100	6	215	101	55.75	242	47.00
F 02465	315	3	3535	45-90	14	178	91	3	257	25.00
F 02466	315	4	3535	45-90	6	178	91	9.75	257	32.00
F 02467	315	5	3535	45-90	6	178	91	22.5	257	30.00
F 02468	315	6	4040	55-100	6	215	101	30.25	257	45.50
F 02469	315	8	4040	55-100	6	215	101	55.75	257	47.00
F 02470	335	3	3535	45-90	14	178	91	3	277	25.00
F 02471	335	4	3535	45-90	6	178	91	9.75	277	32.00
F 02472	335	5	3535	45-90	6	178	91	22.5	277	34.32
F 02473	335	6	4040	55-100	6	215	101	30.25	277	45.00
F 02474	335	8	4040	55-100	6	215	101	55.75	277	50.50
F 02475	355	3	3535	45-90	14	178	91	3	297	25.00
F 02476	355	4	3535	45-90	6	178	91	9.75	297	32.06
F 02477	355	5	4040	55-100	6	215	101	17.5	297	39.00
F 02478	355	6	4040	55-100	6	215	101	30.25	297	45.00
F 02479	355	8	4040	55-100	6	215	101	55.75	297	55.00

Rozměry uvedeny v mm.

Klínové řemenice PBT pro TaperLock®

Materiál

Šedá litina

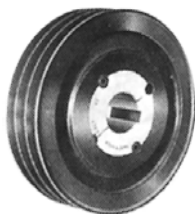

SPC-C

Obj. číslo	Výpočtový Ø dw	Počet drážek	Pouzdro TaperLock®	Otvor min./max.	Prove- dení	M	L	Z	U	 kg
F 02480	400	3	3535	45-90	3	178	91	3	342	33.00
F 02481	400	4	3535	45-90	9	178	91	9.75	342	34.00
F 02482	400	5	4040	55-100	9	215	101	17.5	342	45.50
F 02483	400	6	4040	55-100	9	215	101	30.25	342	47.00
F 02484	400	8	5050	70-125	6	267	126	43.25	342	76.00
F 02096	450	3	3535	45-90	3	178	91	3	392	33.00
F 02485	450	4	3535	45-90	9	178	91	9.75	392	38.50
F 02486	450	5	4040	55-100	9	215	101	17.5	392	54.50
F 02487	450	6	4040	55-100	9	215	101	30.25	392	61.00
F 02488	450	8	5050	70-125	6	267	126	43.25	392	84.00
F 02489	500	3	3535	45-90	3	178	91	3	442	40.00
F 02490	500	4	4040	55-100	9	215	101	4.75	442	53.50
F 02491	500	5	4040	55-100	9	215	101	17.5	442	60.00
F 02492	500	6	4040	55-100	9	215	101	30.25	442	69.00
F 02493	500	8	5050	70-125	9	267	126	43.25	442	90.00
F 02494	560	3	3535	45-90	3	178	91	3	502	45.00
F 02495	560	4	4040	55-100	9	215	101	4.75	502	61.00
F 02496	560	5	4040	55-100	9	215	101	17.5	502	64.00
F 02497	560	6	5050	70-125	9	267	126	17.75	502	86.00
F 02498	560	8	5050	70-125	9	267	126	43.25	502	107.00
F 02499	630	3	4040	55-100	3	215	101	8	572	57.00
F 02500	630	4	4040	55-100	9	215	101	4.75	572	68.00
F 02501	630	5	5050	70-125	9	267	126	5	572	90.80
F 02502	630	6	5050	70-125	9	267	126	17.75	572	100.00
F 02503	630	8	5050	70-125	9	267	126	43.25	572	114.00
F 02504	710	3	4040	55-100	3	215	101	8	652	67.00
F 02505	710	4	4040	55-100	9	215	101	4.75	652	80.00
F 02506	710	5	5050	70-125	9	267	126	5	652	101.00
F 02507	710	6	5050	70-125	9	267	126	17.75	652	115.00
F 02508	710	8	5050	70-125	9	267	126	43.25	652	138.50
F 02509	800	3	4040	55-100	3	215	101	8	742	82.00
F 02510	800	4	5050	70-125	3	267	126	7.75	742	120.00
F 02511	800	5	5050	70-125	9	267	126	5	742	132.00
F 02512	800	6	5050	70-125	9	267	126	17.75	742	136.00
F 02513	800	8	5050	70-125	9	267	126	43.25	742	154.00
F 02514	1000	3	4040	55-100	3	215	101	8	942	110.00
F 02515	1000	4	5050	70-125	3	267	126	7.75	942	139.00
F 02516	1000	5	5050	70-125	9	267	126	5	942	133.00
F 02517	1000	6	5050	70-125	9	267	126	17.75	942	158.00
F 02518	1000	8	5050	70-125	9	267	126	43.25	942	206.00
F 02519	1250	3	5050	70-125	3	267	126	20.5	1190	138.00
F 02520	1250	4	5050	70-125	3	267	126	7.75	1190	184.00
F 02521	1250	5	5050	70-125	9	267	126	5	1190	192.00
F 02522	1250	6	5050	70-125	9	267	126	17.75	1190	212.00
F 02523	1250	8	5050	70-125	9	267	126	43.25	1190	274.00

Rozměry uvedeny v mm.

Klínové řemenice PT

polotovár bez předvrtaného otvoru

Materiál

Šedá litina

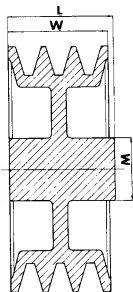

Provedení D

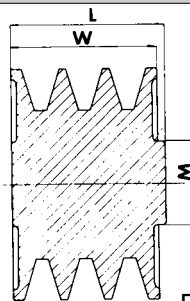

Provedení P

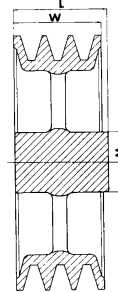

Provedení R

SPZ-Z-3V

Obj. číslo	Výpočtový Ø dw	Počet drážek	Provedení	M	L	kg	Obj. číslo	Výpočtový Ø dw	Počet drážek	Provedení	M	L	kg
F06088	50	1	P	32	28	0,2	F06133	140	1	D	45	28	1,1
F06089	50	2	P	35	35	0,32	F06134	140	2	D	60	40	1,75
F06090	50	3	P	35	44	0,45	F06135	140	3	D	60	40	2,4
F06091	56	1	P	32	28	0,25	F06136	150	1	D	55	32	1,3
F06092	56	2	P	40	35	0,4	F06137	150	2	D	60	40	2
F06093	56	3	P	42	44	0,55	F06138	150	3	D	68	45	2,8
F06094	63	1	P	40	28	0,4	F06139	160	1	D	55	32	1,45
F06095	63	2	P	40	35	0,55	F06140	160	2	D	60	40	2,2
F06096	63	3	P	42	44	0,7	F06141	160	3	D	68	45	3
F06097	71	1	P	40	28	0,45	F06142	180	1	D	55	32	1,8
F06098	71	2	P	48	35	0,67	F06143	180	2	D	60	40	2,65
F06099	71	3	P	50	44	1	F06144	180	3	D	68	45	3,5
F06100	75	1	P	40	28	0,48	F06145	200	1	D-6F	55	32	1,9
F06101	75	2	P	50	35	0,79	F06146	200	2	D-6F	65	40	2,35
F06102	75	3	P	50	44	1,1	F06147	200	3	D-6F	68	45	2,8
F06103	80	1	D	40	28	0,49	F06148	224	1	3R	55	32	2
F06104	80	2	P	50	35	0,84	F06149	224	2	3R	65	40	3,1
F06105	80	3	P	50	44	1,2	F06150	224	3	3R	68	45	4,4
F06106	85	1	D	40	28	0,5	F06151	250	1	3R	55	32	2,3
F06107	85	2	D	50	35	0,9	F06152	250	2	3R	62	40	3,5
F06108	85	3	P	50	44	1,3	F06153	250	3	3R	68	45	4,7
F06109	90	1	D	40	28	0,55	F06154	280	1	3R	68	45	3,45
F06110	90	2	D	50	35	1	F06155	280	2	3R	68	45	4,7
F06111	90	3	D	50	44	1,5	F06156	280	3	3R	80	50	6
F06112	95	1	D	45	28	0,65	F06157	315	1	3R	68	45	4,3
F06113	95	2	D	50	35	1,2	F06158	315	2	3R	68	45	5,7
F06114	95	3	D	50	40	1,7	F06159	315	3	3R	80	50	7,1
F06115	100	1	D	45	28	0,7	F06160	355	1	3R	68	45	4,8
F06116	100	2	D	50	35	1,3	F06161	355	2	3R	68	45	6,4
F06117	100	3	D	60	40	1,9	F06162	355	3	3R	80	50	8
F06118	106	1	D	45	28	0,75							
F06119	106	2	D	50	35	1,4							
F06120	106	3	D	60	40	2							
F06121	112	1	D	45	28	0,85							
F06122	112	2	D	50	35	1,5							
F06123	112	3	D	60	40	2,1							
F06124	118	1	D	45	28	0,9							
F06125	118	2	D	50	35	1,4							
F06126	118	3	D	60	40	1,9							
F06127	125	1	D	45	28	0,95							
F06128	125	2	D	50	35	1,6							
F06129	125	3	D	60	40	2,2							
F06130	132	1	D	45	28	1							
F06131	132	2	D	50	40	1,65							
F06132	132	3	D	60	40	2,3							

Rozměry uvedeny v mm.

Klínové řemenice PT

polotovary bez předvrtaného otvoru

Materiál

Šedá litina

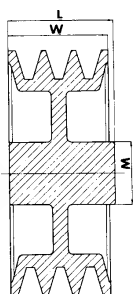

Provedení D

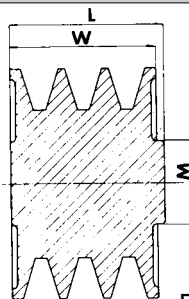

Provedení P

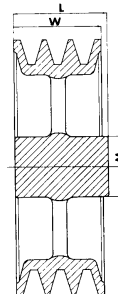

Provedení R

SPA-A

Obj. číslo	Výpočtový Ø dw	Počet drážek	Provedení	M	L	kg	Obj. číslo	Výpočtový Ø dw	Počet drážek	Provedení	M	L	kg
F05780	50	1	P	32	35	0,27	F05825	106	2	D	60	45	1,7
F05781	50	2	P	40	45	0,44	F05826	106	3	D	60	50	2,5
F05782	50	3	P	40	54	0,6	F05827	106	4	P	68	50	3,1
F05783	56	1	P	35	35	0,35	F05828	112	1	D	45	35	0,96
F05784	56	2	P	40	45	0,5	F05829	112	2	D	60	45	1,83
F05785	56	3	P	40	54	0,7	F05830	112	3	D	60	50	2,7
F05786	63	1	P	40	35	0,4	F05831	112	4	P	68	50	3,15
F05787	63	2	P	40	45	0,68	F05832	112	5	P	68	50	3,6
F05788	63	3	P	40	54	0,9	F05833	118	1	D	60	35	1,2
F05789	63	4	P	40	68	1,12	F05834	118	2	D	60	45	2,17
F05790	63	5	P	40	84	1,35	F05835	118	3	D	70	50	3,15
F05791	71	1	P	40	35	0,62	F05836	118	4	P	70	50	3,57
F05792	71	2	P	50	45	0,88	F05837	118	5	P	80	50	4
F05793	71	3	P	52	54	1,15	F05838	125	1	D	55	35	1,3
F05794	71	4	P	52	68	1,5	F05839	125	2	D	60	45	2,1
F05795	71	5	P	52	84	1,85	F05840	125	3	D	68	50	2,9
F05796	75	1	P	40	35	0,56	F05841	125	4	D	68	50	3,7
F05797	75	2	P	50	45	0,9	F05842	125	5	D	80	50	4,5
F05798	75	3	P	52	54	1,25	F05843	132	1	D	55	35	1,4
F05799	75	4	P	52	68	1,6	F05844	132	2	D	60	45	2,15
F05800	75	5	P	52	84	2	F05845	132	3	D	68	50	2,9
F05801	80	1	P	45	35	0,69	F05846	132	4	D	68	50	3,95
F05802	80	2	P	50	45	1,1	F05847	132	5	D	80	50	5
F05803	80	3	P	62	54	1,55	F05848	140	1	D	60	35	1,5
F05804	80	4	P	62	68	1,95	F05849	140	2	D	60	45	2,35
F05805	80	5	P	62	84	2,35	F05850	140	3	D	68	50	3,2
F05806	85	1	D	45	35	0,71	F05851	140	4	D	68	50	4
F05807	85	2	P	50	45	1,2	F05852	140	5	D	80	50	4,9
F05808	85	3	P	62	54	1,75	F05853	150	1	D	60	40	1,8
F05809	85	4	P	62	68	2,25	F05854	150	2	D	60	45	2,65
F05810	90	1	D	45	35	0,75	F05855	150	3	D	68	50	3,5
F05811	90	2	P	60	45	1,32	F05856	150	4	D	68	50	4,25
F05812	90	3	P	62	54	1,9	F05857	150	5	D	80	50	5
F05813	90	4	P	68	68	2,35	F05858	160	1	D	60	40	2
F05814	90	5	P	68	84	2,8	F05859	160	2	D	60	45	2,87
F05815	95	1	D	45	35	0,82	F05860	160	3	D	68	50	3,75
F05816	95	2	P	60	45	1,51	F05861	160	4	D	80	50	4,5
F05817	95	3	P	62	54	2,2	F05862	170	1	D	60	40	2,1
F05818	95	4	P	68	68	2,9	F05863	170	2	D	60	45	3
F05819	100	1	D	45	35	0,87	F05864	170	3	D	68	50	3,9
F05820	100	2	P	60	45	1,61	F05865	170	4	D	80	50	4,8
F05821	100	3	P	62	54	2,35	F05866	180	1	D	65	40	2,5
F05822	100	4	P	70	50	2,6	F05867	180	2	D	68	50	3,35
F05823	100	5	P	70	50	3	F05868	180	3	D	68	50	4,2
F05824	106	1	D	45	35	0,91	F05869	180	4	D	80	60	5,5

Rozměry uvedeny v mm.

Klínové řemenice PT

polotovár bez předvrtaného otvoru

Materiál

Šedá litina

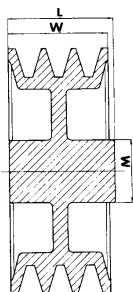

Provedení D

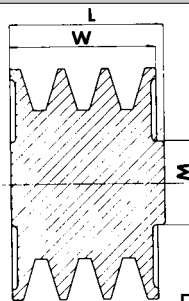

Provedení P

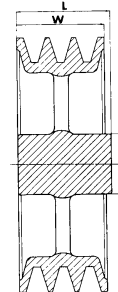

Provedení R

SPA-A

Obj. číslo	Výpočtový Ø dw	Počet drážek	Provedení	M	L	$\frac{M}{L}$ kg	Obj. číslo	Výpočtový Ø dw	Počet drážek	Provedení	M	L	$\frac{M}{L}$ kg
F05870	180	5	D	80	65	6,8	F05915	400	3	6R	96	65	12,7
F05871	190	1	D	65	40	2,6	F05916	400	4	6R	96	65	15,1
F05872	190	2	D	68	50	3,5	F05917	400	5	6R	96	70	17,6
F05873	190	3	D	68	50	4,4							
F05874	190	4	D	80	60	5,3							
F05875	190	5	D	80	65	7,5							
F05876	200	1	D-6F	65	40	3,1							
F05877	200	2	D-6F	68	50	4,15							
F05878	200	3	D-8F	75	50	5,2							
F05879	200	4	D	88	60	6,35							
F05880	200	5	D	88	65	7,5							
F05881	224	1	D-6F	65	40	3,2							
F05882	224	2	D-6F	68	50	5,25							
F05883	224	3	D-6F	75	50	7,3							
F05884	224	4	D-6F	88	60	7,75							
F05885	224	5	D-6F	88	65	8,2							
F05886	236	1	D-6F	68	40	3,7							
F05887	236	2	D-6F	68	50	4,75							
F05888	236	3	D-6F	75	50	5,8							
F05889	236	4	D-8F	88	60	7							
F05890	236	5	D-8F	88	65	8,3							
F05891	250	1	3R	75	50	3,6							
F05892	250	2	3R	75	50	4,75							
F05893	250	3	3R	75	50	5,9							
F05894	250	4	3R	88	60	8,4							
F05895	250	5	3R	96	65	10,9							
F05896	280	1	3R	68	50	3,7							
F05897	280	2	3R	75	50	5							
F05898	280	3	3R	75	50	6,3							
F05899	280	4	3R	88	60	8,65							
F05900	280	5	3R	96	65	11							
F05901	300	1	3R	75	50	4,2							
F05902	300	2	3R	75	50	5,95							
F05903	300	3	3R	88	60	7,7							
F05904	300	4	3R	88	60	9,35							
F05905	300	5	3R	96	70	11							
F05906	315	2	3R	75	50	6							
F05907	315	3	3R	88	60	8							
F05908	315	4	3R	88	60	10							
F05909	315	5	3R	96	70	12							
F05910	355	2	3R	88	60	7,5							
F05911	355	3	3R	88	60	9,3							
F05912	355	4	3R	88	60	11,1							
F05913	355	5	3R	96	70	13							
F05914	400	2	6R	88	60	10,3							

Rozměry uvedeny v mm.

Klínové řemenice PT

polotovár bez předvrtaného otvoru

Materiál

Šedá litina

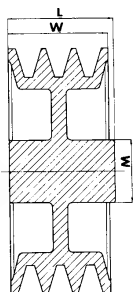

Provedení D

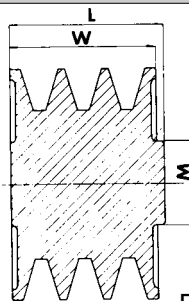

Provedení P

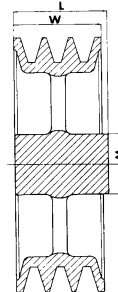

Provedení R

SPB-B-5V

Obj. číslo	Výpočtový Ø dw	Počet drážek	Provedení	M	L	$\frac{m}{kg}$	Obj. číslo	Výpočtový Ø dw	Počet drážek	Provedení	M	L	$\frac{m}{kg}$
F05918	60	1	P	40	35	0,45	F05963	125	2	D	60	48	2,4
F05919	60	2	P	40	48	0,8	F05964	125	3	D	75	50	3,3
F05920	71	1	P	45	35	0,65	F05965	125	4	D	75	50	4,2
F05921	71	2	P	45	48	1	F05966	125	5	D	75	50	5
F05922	71	3	P	45	67	1,4	F05967	125	6	P	80	60	6
F05923	75	1	P	45	35	0,7	F05968	132	1	D	60	35	1,6
F05924	75	2	P	45	48	1,1	F05969	132	2	D	60	50	2,6
F05925	75	3	P	45	67	1,5	F05970	132	3	D	75	50	3,6
F05926	80	1	P	50	35	0,75	F05971	132	4	D	80	50	4,6
F05927	80	2	P	50	48	1,4	F05972	132	5	D	80	60	5,6
F05928	80	3	P	50	67	2	F05973	132	6	D	80	60	6,75
F05929	80	4	P	52	86	2,6	F05974	140	1	D	60	35	1,65
F05930	80	5	P	58	105	2,9	F05975	140	2	D	65	50	2,9
F05931	85	1	P	50	35	1	F05976	140	3	D	75	50	4,1
F05932	85	2	P	50	48	1,85	F05977	140	4	D	80	50	5,3
F05933	85	3	P	52	67	2,7	F05978	140	5	D	80	60	6,5
F05934	90	1	P	50	35	1	F05979	140	6	D	80	60	7,8
F05935	90	2	P	50	48	1,45	F05980	150	1	D	60	40	2
F05936	90	3	P	58	67	1,9	F05981	150	2	D	65	50	3,3
F05937	90	4	P	65	50	2,35	F05982	150	3	D	75	50	4,6
F05938	95	1	P	52	35	1	F05983	150	4	D	80	50	5,9
F05939	95	2	P	55	48	1,5	F05984	150	5	D	80	60	7,2
F05940	95	3	P	58	67	2	F05985	150	6	D	88	60	8,5
F05941	95	4	P	65	50	2,6	F05986	160	1	D	65	40	2,2
F05942	95	5	P	65	50	3	F05987	160	2	D	68	50	3,55
F05943	100	1	P	52	35	1,05	F05988	160	3	D	80	50	4,9
F05944	100	2	P	55	48	1,7	F05989	160	4	D	88	60	6,25
F05945	100	3	P	58	67	2,35	F05990	160	5	D	88	60	7,6
F05946	100	4	P	65	50	2,95	F05991	160	6	D	88	65	8,9
F05947	100	5	P	65	50	3,6	F05992	170	1	D	65	40	2,5
F05948	106	1	P	50	35	1,1	F05993	170	2	D	68	50	4
F05949	106	2	P	55	48	1,8	F05994	170	3	D	80	50	5,5
F05950	106	3	P	65	50	2,5	F05995	170	4	D	88	60	7
F05951	106	4	P	65	50	3,3	F05996	170	5	D	88	60	8,6
F05952	112	1	D	55	35	1,2	F05997	170	6	D	104	65	10,2
F05953	112	2	D	60	48	2	F05998	180	1	D	65	40	2,6
F05954	112	3	P	65	50	2,8	F05999	180	2	D	68	50	4,3
F05955	112	4	P	75	50	3,6	F06000	180	3	D	80	50	6
F05956	112	5	P	75	50	4,3	F06001	180	4	D	88	60	7,7
F05957	118	1	D	55	35	1,3	F06002	180	5	D	88	70	9,4
F05958	118	2	D	60	48	2,1	F06003	180	6	D	104	70	10,9
F05959	118	3	P	75	50	2,9	F06004	190	1	D	65	40	2,85
F05960	118	4	P	75	50	3,7	F06005	190	2	D	68	50	4,1
F05961	118	5	P	75	50	4,5	F06006	190	3	D	80	50	5,3
F05962	125	1	D	55	35	1,5	F06007	190	4	D	88	60	6,55

Rozměry uvedeny v mm.

Klínové řemenice PT

polotovár bez předvrtaného otvoru

Materiál

Šedá litina

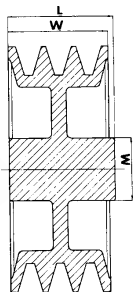

Provedení D

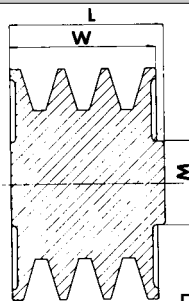

Provedení P

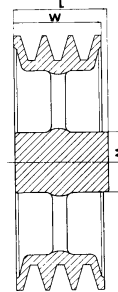

Provedení R

SPB-B-5V

Obj. číslo	Výpočtový Ø dw	Počet drážek	Provedení	M	L	$\frac{m}{kg}$	Obj. číslo	Výpočtový Ø dw	Počet drážek	Provedení	M	L	$\frac{m}{kg}$
F06008	190	5	D	88	70	7,8	F06053	315	6	3R	120	90	12,6
F06009	200	1	D	68	40	3,1	F06054	355	2	3R	88	60	10
F06010	200	2	D	68	50	5	F06055	355	3	3R	96	60	13,9
F06011	200	3	D	80	50	7	F06056	355	4	3R	96	65	17,8
F06012	200	4	D	88	60	9	F06057	355	5	3R	104	75	21,7
F06013	200	5	D	88	70	11	F06058	355	6	3R	120	90	25,6
F06014	200	6	D	104	80	13,05	F06059	400	2	6R	88	60	13,4
F06015	212	1	D-6F	68	45	3,5	F06060	400	3	6R	96	65	18,5
F06016	212	2	D-6F	68	50	4,5	F06061	400	4	6R	104	75	23,6
F06017	212	3	D	80	50	7,5	F06062	400	5	6R	112	85	28,7
F06018	212	4	D	88	60	9,4	F06063	400	6	6R	120	100	33,8
F06019	224	1	D-6F	68	45	4	F06064	450	2	6R	88	60	16,6
F06020	224	2	D-6F	75	50	6	F06065	450	3	6R	96	65	20,8
F06021	224	3	D-6F	80	50	8	F06066	450	4	6R	104	75	25
F06022	224	4	D	88	60	10	F06067	450	5	6R	112	85	31
F06023	224	5	D	96	70	12	F06068	450	6	6R	120	100	36
F06024	224	6	D	104	80	13,8	F06069	500	2	6R	96	65	17,5
F06025	236	1	D-6F	68	45	4,2	F06070	500	3	6R	104	75	23
F06026	236	2	D-6F	75	50	5,4	F06071	500	4	6R	112	85	28,6
F06027	236	3	D-6F	80	60	7,6	F06072	500	5	6R	120	90	33
F06028	236	4	D-6F	88	65	9,8	F06073	500	6	SR	128	105	43
F06029	236	5	D-6F	96	75	12	F06074	560	2	6R	96	65	18,9
F06030	236	6	D	104	80	15,2	F06075	560	3	6R	104	75	25,2
F06031	250	1	3R	70	45	3,6	F06076	560	4	6R	112	85	31,7
F06032	250	2	3R	75	50	5,9	F06077	560	5	6R	120	90	39,5
F06033	250	3	3R	88	60	8,2	F06078	560	6	6R	128	105	46,9
F06034	250	4	3R	96	65	10,5	F06079	630	2	6R	104	75	21,2
F06035	250	5	D-6F	104	75	12,8	F06080	630	3	6R	120	90	30,1
F06036	250	6	D-6F	104	80	15,2	F06081	630	4	6R	128	105	38,2
F06037	280	1	3R	75	45	4,8	F06082	630	5	6R	145	115	48,3
F06038	280	2	3R	75	50	7,5	F06083	630	6	6R	145	115	56,2
F06039	280	3	3R	88	60	10,2	F06084	710	2	6R	96	65	25
F06040	280	4	3R	96	65	12,9	F06085	710	3	6R	112	75	35
F06041	280	5	3R	104	75	15,6	F06086	710	4	6R	120	90	45
F06042	280	6	3R	104	80	18,3	F06087	710	5	6R	128	105	55
F06043	300	1	3R	75	50	5,9							
F06044	300	2	3R	80	50	8,6							
F06045	300	3	3R	88	60	11,2							
F06046	300	4	3R	96	65	13,8							
F06047	300	5	3R	104	75	16,4							
F06048	300	6	3R	104	80	19							
F06049	315	2	3R	88	60	9,4							
F06050	315	3	3R	88	60	10,2							
F06051	315	4	3R	96	65	11							
F06052	315	5	3R	104	75	11,8							

Rozměry uvedeny v mm.



PYB - řemenice pro drážkové řemeny Micro-V®

Použití:

Tyto řemenice jsou vhodné pro drážkové klínové řemeny typu "J" a "L".

Materiál / technické informace:

PYB řemenice pro drážkové řemeny jsou vyrobeny z litiny GG25, kvalita dle DIN1691.

Charakteristika:

Rozměry řemenic jsou velice přesné, protože všechny řemenice jsou vyráběny na CNC strojích nebo automatických soustruzích. Tyto řemenice mohou být používány pro obvodovou rychlost 60 m/s v "J" provedení.

Povrchová úprava:

Řemenice jsou černě fosfátovány.

Vyváženost:

PYB řemenice pro drážkové klínové řemeny Micro-V® jsou staticky vyvážené.

Tolerance (viz. tabulka níže):

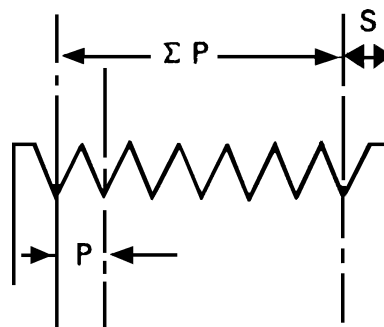
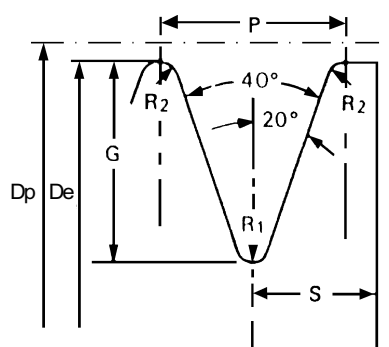

Profil	P [mm]	G [mm]	R ₂ [mm]	R ₁ [mm]	S _{min} [mm]	ΣP tolerance [mm]	Dp - De [mm]
J	2.34 ±0.025	2.21 ±0.13	0.20	0.32 ±0.06	2.0	±0.25	2
L	4.70 ±0.050	5.11 ±0.13	0.38	0.32 ±0.06	4.0	±0.25	5



PYB - řemenice Micro-V[®] pro TaperLock[®]

Schématu jednotlivých provedení:

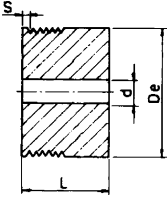
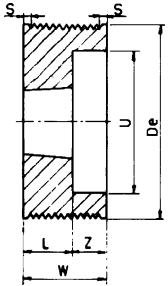
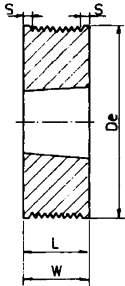
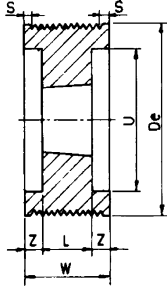
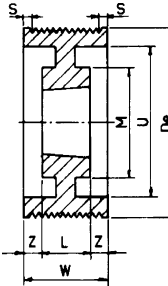
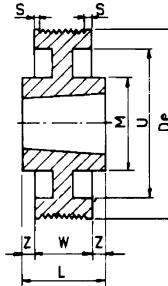
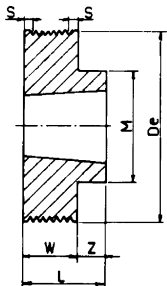
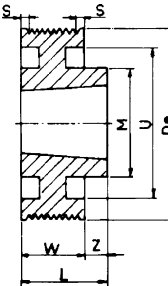
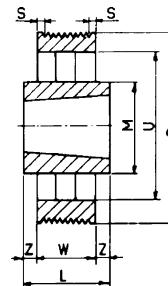
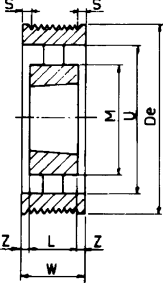
 <p>Provedení 1</p>	 <p>Provedení 2</p>	 <p>Provedení 3</p>
 <p>Provedení 4</p>	 <p>Provedení 5</p>	 <p>Provedení 6</p>
 <p>Provedení 7</p>	 <p>Provedení 8</p>	 <p>Provedení 9</p>
 <p>Provedení 10</p>		

Řemenice pro drážkové řemeny Micro-V® pro TaperLock®

Materiál

Šedá litina



Pro řemeny J

Obj. číslo	Vnější Ø de	Počet drážek	Pouzdro TaperLock®	Provedení	W	S	L	Z	M	U	d
F 03314	20	4	-	1	13.5	3.24	22.5	-	-	-	5
F 03315	20	8	-	1	23	3.31	32	-	-	-	5
F 03316	20	12	-	1	32.5	3.38	41.5	-	-	-	5
F 03317	20	16	-	1	42	3.45	51	-	-	-	5
F 03318	20	20	-	1	52	3.77	61	-	-	-	5
F 02751	25	4	-	1	13.5	3.24	22.5	-	-	-	5
F 03319	25	8	-	1	23	3.31	32	-	-	-	5
F 03320	25	12	-	1	32.5	3.38	41.5	-	-	-	5
F 03321	25	16	-	1	42	3.45	51	-	-	-	5
F 03653	25	20	-	1	52	3.77	61	-	-	-	5
F 03322	30	4	-	1	13.5	3.24	22.5	-	-	-	9.5
F 03323	30	8	-	1	23	3.31	32	-	-	-	9.5
F 03324	30	12	-	1	32.5	3.38	41.5	-	-	-	9.5
F 03325	30	16	-	1	42	3.45	51	-	-	-	9.5
F 03654	30	20	-	1	52	3.77	61	-	-	-	9.5
F 03326	35	4	-	1	13.5	3.24	22.5	-	-	-	9.5
F 03327	35	8	-	1	23	3.31	32	-	-	-	9.5
F 03328	35	12	-	1	32.5	3.38	41.5	-	-	-	9.5
F 03329	35	16	-	1	42	3.45	51	-	-	-	9.5
F 03655	35	20	-	1	52	3.77	61	-	-	-	9.5
F 03330	40	4	-	1	13.5	3.24	22.5	-	-	-	12
F 03331	40	8	-	1	23	3.31	32	-	-	-	12
F 03332	40	12	-	1	32.5	3.38	41.5	-	-	-	12
F 03333	40	16	-	1	42	3.45	51	-	-	-	12
F 03656	40	20	-	1	52	3.77	61	-	-	-	12
F 03334	45	4	-	1	13.5	3.24	22.5	-	-	-	12
F 03335	45	8	-	1	23	3.31	32	-	-	-	12
F 03336	45	12	-	1	32.5	3.38	41.5	-	-	-	12
F 03337	45	16	-	1	42	3.45	51	-	-	-	12
F 03338	45	20	-	1	52	3.77	61	-	-	-	12
F 02619	50	4	-	1	13.5	3.24	22.5	-	-	-	12
F 03339	50	8	-	1	23	3.31	32	-	-	-	12
F 03340	50	12	-	1	32.5	3.38	41.5	-	-	-	12
F 03341	50	16	-	1	42	3.45	51	-	-	-	12
F 03657	50	20	-	1	52	3.77	61	-	-	-	12
F 03342	56	4	1108	7	13.5	3.24	23	9.5	50	-	-
F 03343	56	8	1108	3	23	3.31	23	-	-	-	-
F 03344	56	12	-	1	32.5	3.38	41.5	-	-	-	12
F 03345	56	16	-	1	42	3.45	51	-	-	-	12
F 03658	56	20	-	1	52	3.77	61	-	-	-	12

Rozměry uvedeny v mm.

Řemenice pro drážkové řemeny Micro-V® pro TaperLock®

Materiál

Šedá litina



Pro řemeny J

Obj. číslo	Vnější Ø de	Počet drážek	Pouzdro TaperLock®	Provedení	W	S	L	Z	M	U	d
F 02712	60	4	1108	7	13.5	3.24	23	9.5	50	-	-
F 03347	60	8	1108	3	23	3.31	23	-	-	-	-
F 03348	60	12	1108	2	32.5	3.38	23	9.5	-	45	-
F 03349	60	16	-	1	42	3.45	51	-	-	-	12
F 03346	60	20	-	1	52	3.77	61	-	-	-	12
F 03350	63	4	1108	7	13.5	3.24	23	9.5	50	-	-
F 03351	63	8	1108	3	23	3.31	23	-	-	-	-
F 03352	63	12	1108	2	32.5	3.38	23	9.5	-	45	-
F 03353	63	16	-	1	42	3.45	51	-	-	-	12
F 03659	63	20	-	1	52	3.77	61	-	-	-	12
F 03354	67	4	1108	7	13.5	3.24	23	9.5	50	-	-
F 03355	67	8	1108	3	23	3.31	23	-	-	-	-
F 03356	67	12	1108	2	32.5	3.38	23	9.5	-	51	-
F 03357	67	16	-	1	42	3.45	51	-	-	-	12
F 03660	67	20	-	1	52	3.77	61	-	-	-	12
F 03358	71	4	1108	7	13.5	3.24	23	9.5	60	-	-
F 03359	71	8	1108	3	23	3.31	23	-	-	-	-
F 03360	71	12	1108	2	32.5	3.38	23	9.5	-	55	-
F 03361	71	16	1215	3	42	3.45	42	-	-	55	-
F 02750	71	20	1215	2	52	3.77	42	10	-	55	-
F 03362	75	4	1108	7	13.5	3.24	23	9.5	60	-	-
F 03363	75	8	1108	3	23	3.31	23	-	-	-	-
F 03364	75	12	1210	2	32.5	3.38	26	6.5	-	59	-
F 03365	75	16	1610	2	42	3.45	26	16	-	59	-
F 03362	75	20	1615	2	52	3.77	42	10	-	59	-
F 03366	80	4	1310	7	13.5	3.24	26	12.5	70	-	-
F 03367	80	8	1310	7	23	3.31	26	3	70	-	-
F 03368	80	12	1610	2	32.5	3.38	26	6.5	-	64	-
F 03369	80	16	1610	2	42	3.45	26	16	-	64	-
F 03662	80	20	1615	2	52	3.77	42	10	-	64	-
F 03370	85	4	1310	7	13.5	3.24	26	12.5	70	-	-
F 03371	85	8	1310	7	23	3.31	26	3	70	-	-
F 03372	85	12	1610	2	32.5	3.38	26	6.5	-	69	-
F 03373	85	16	1610	2	42	3.45	26	16	-	69	-
F 03663	85	20	1615	2	52	3.77	42	10	-	69	-
F 03374	90	4	1610	7	13.5	3.24	26	12.5	82	-	-
F 03375	90	8	1610	7	23	3.31	26	3	82	-	-
F 03376	90	12	1610	2	32.5	3.38	26	6.5	-	74	-
F 03377	90	16	1610	2	42	3.45	26	16	-	74	-
F 03664	90	20	1615	2	52	3.77	42	10	-	74	-

Rozměry uvedeny v mm.

Řemenice pro drážkové řemeny Micro-V® pro TaperLock®

Materiál

Šedá litina



Pro řemeny J

Obj. číslo	Vnější Ø de	Počet drážek	Pouzdro TaperLock®	Provedení	W	S	L	Z	M	U	d
F 03378	95	4	1610	7	13.5	3.24	26	12.5	82	-	-
F 03379	95	8	1610	7	23	3.31	26	3	82	-	-
F 03380	95	12	1610	2	32.5	3.38	26	6.5	-	79	-
F 02744	95	16	1610	2	42	3.45	26	16	-	79	-
F 03381	95	20	1615	2	52	3.77	42	10	-	79	-
F 03382	100	4	1610	7	13.5	3.24	26	12.5	82	-	-
F 03383	100	8	1610	7	23	3.31	26	3	82	-	-
F 03384	100	12	1610	2	32.5	3.38	26	6.5	-	82	-
F 03385	100	16	1610	2	42	3.45	26	16	-	82	-
F 03665	100	20	1615	2	52	3.77	42	10	-	82	-
F 03386	106	4	1610	7	13.5	3.24	26	12.5	88	-	-
F 02979	106	8	1610	7	23	3.31	26	3	88	-	-
F 03388	106	12	1610	2	32.5	3.38	26	6.5	-	88	-
F 03389	106	16	1610	2	42	3.45	26	16	-	88	-
F 03387	106	20	1615	2	52	3.77	42	10	-	88	-
F 03390	112	4	1610	7	13.5	3.24	26	12.5	90	-	-
F 03391	112	8	1610	7	23	3.31	26	3	90	-	-
F 03392	112	12	1610	2	32.5	3.38	26	6.5	-	94	-
F 03393	112	16	1610	2	42	3.45	26	16	-	94	-
F 03666	112	20	1615	2	52	3.77	42	10	-	94	-
F 02978	118	4	1610	7	13.5	3.24	26	12.5	90	-	-
F 03395	118	8	1610	7	23	3.31	26	3	90	-	-
F 03396	118	12	2012	2	32.5	3.38	32	0.5	-	98	-
F 03397	118	16	2012	2	42	3.45	32	10	-	98	-
F 03394	118	20	2012	2	52	3.77	32	20	-	98	-
F 03398	125	4	1610	8	13.5	3.24	26	12.5	90	109	-
F 03399	125	8	1610	8	23	3.31	26	3	90	109	-
F 03400	125	12	2012	2	32.5	3.38	32	0.5	-	105	-
F 03401	125	16	2012	2	42	3.45	32	10	-	105	-
F 03667	125	20	2517	2	52	3.77	45	7	-	105	-
F 03402	132	4	1610	8	13.5	3.24	26	12.5	90	116	-
F 03403	132	8	1610	8	23	3.31	26	3	90	116	-
F 03404	132	12	2012	2	32.5	3.38	32	0.5	-	112	-
F 03405	132	16	2012	2	42	3.45	32	10	-	112	-
F 03799	132	20	2517	2	52	3.77	45	7	-	112	-
F 03406	140	4	1610	8	13.5	3.24	26	12.5	90	124	-
F 03407	140	8	1610	8	23	3.31	26	3	90	124	-
F 03408	140	12	2517	7	32.5	3.38	45	12.5	120	-	-
F 03409	140	16	2517	7	42	3.45	45	3	120	-	-
F 03668	140	20	2517	2	52	3.77	45	7	-	124	-
F 03410	160	4	2012	8	13.5	3.24	32	18.5	110	144	-
F 03411	160	8	2012	8	23	3.31	32	9	110	144	-
F 03412	160	12	2517	8	32.5	3.38	45	12.5	120	140	-
F 03413	160	16	2517	8	42	3.45	45	3	120	140	-
F 03669	160	20	2517	2	52	3.77	45	7	-	140	-

Rozměry uvedeny v mm.

Řemenice pro drážkové řemeny Micro-V® pro TaperLock®

Materiál

Šedá litina



Pro řemeny J

Obj. číslo	Vnější Ø de	Počet drážek	Pouzdro TaperLock®	Provedení	W	S	L	Z	M	U	d
F 03414	180	4	2012	6	13.5	3.24	32	9.25	110	164	-
F 03415	180	8	2012	6	23	3.31	32	4.5	110	164	-
F 03416	180	12	2517	6	32.5	3.38	45	6.25	120	160	-
F 03417	180	16	2517	6	42	3.45	45	1.5	120	160	-
F 03670	180	20	2517	5	52	3.77	45	3.5	120	160	-
F 03418	200	4	2012	6	13.5	3.24	32	9.25	110	185	-
F 03419	200	8	2012	6	23	3.31	32	4.5	110	185	-
F 03420	200	12	2517	6	32.5	3.38	45	6.25	120	180	-
F 03421	200	16	2517	6	42	3.45	45	1.5	120	180	-
F 03671	200	20	2517	5	52	3.77	45	3.5	120	180	-
F 03422	224	4	2012	6	13.5	3.24	32	9.25	110	208	-
F 03423	224	8	2012	6	23	3.31	32	4.5	110	208	-
F 03424	224	12	2517	6	32.5	3.38	45	6.25	120	204	-
F 03425	224	16	2517	6	42	3.45	45	1.5	120	204	-
F 03672	224	20	2517	5	52	3.77	45	3.5	120	204	-
F 03426	250	4	2012	9	13.5	3.24	32	9.25	110	234	-
F 03427	250	8	2012	9	23	3.31	32	4.5	110	234	-
F 03428	250	12	2517	6	32.5	3.38	45	6.25	120	230	-
F 03429	250	16	2517	6	42	3.45	45	1.5	120	230	-
F 03673	250	20	2517	5	52	3.77	45	3.5	120	230	-
F 03430	280	4	2012	9	13.5	3.24	32	9.25	110	264	-
F 03431	280	8	2012	9	23	3.31	32	4.5	110	264	-
F 03432	280	12	2517	9	32.5	3.38	45	6.25	120	260	-
F 03433	280	16	2517	9	42	3.45	45	1.5	120	260	-
F 03674	280	20	2517	10	52	3.77	45	3.5	120	260	-
F 03434	315	4	2012	9	13.5	3.24	32	9.25	110	299	-
F 03435	315	8	2012	9	23	3.31	32	4.5	110	299	-
F 03436	315	12	2517	9	32.5	3.38	45	6.25	120	295	-
F 03437	315	16	2517	9	42	3.45	45	1.5	120	295	-
F 03675	315	20	2517	10	52	3.77	45	3.5	120	295	-
F 03438	355	4	2517	9	13.5	3.24	45	15.7	120	339	-
F 03439	355	8	2517	9	23	3.31	45	11	120	339	-
F 03440	355	12	2517	9	32.5	3.38	45	6.25	120	335	-
F 03441	355	16	3020	9	42	3.45	52	5	146	335	-
F 03676	355	20	3020	10	52	3.77	52	-	146	335	-
F 03442	400	4	2517	9	13.5	3.24	45	15.75	120	380	-
F 03443	400	8	2517	9	23	3.31	45	11	120	380	-
F 03444	400	12	2517	9	32.5	3.38	45	6.25	120	380	-
F 03445	400	16	3020	9	42	3.45	52	5	146	380	-
F 03677	400	20	3020	10	52	3.77	52	-	146	380	-

Rozměry uvedeny v mm.

Řemenice pro drážkové řemeny Micro-V® pro TaperLock®

Materiál

Šedá litina



Pro řemeny L

Obj. číslo	Vnější Ø de	Počet drážek	Pouzdro TaperLock®	Provedení	W	S	L	Z	M	U
F 03446	75	6	1210	2	13.5	3.24	26	12.5	-	56
F 03447	75	8	1210	2	23	3.31	26	22	-	56
F 03448	75	10	1215	2	32.5	3.38	42	15	-	56
F 03449	75	12	1215	2	42	3.45	42	25	-	56
F 03450	80	6	1210	2	13.5	3.24	26	12.5	-	56
F 03451	80	8	1210	2	23	3.31	26	22	-	56
F 03452	80	10	1215	2	32.5	3.38	42	15	-	56
F 03453	80	12	1215	2	42	3.45	42	25	-	56
F 03454	85	6	1210	2	13.5	3.24	26	12.5	-	61
F 03455	85	8	1210	2	23	3.31	26	22	-	61
F 03456	85	10	1215	2	32.5	3.38	42	15	-	61
F 03457	85	12	1215	2	42	3.45	42	25	-	61
F 03458	85	16	1215	4	52	3.77	42	22	-	61
F 03459	90	6	1610	2	13.5	3.24	26	12.5	-	66
F 03460	90	8	1610	2	23	3.31	26	22	-	66
F 03461	90	10	1615	2	32.5	3.38	42	15	-	66
F 03462	90	12	1615	2	42	3.45	42	25	-	66
F 03463	90	16	1615	4	52	3.77	42	22	-	66
F 03464	95	6	1210	2	13.5	3.24	26	12.5	-	71
F 03465	95	8	1210	2	23	3.31	26	22	-	71
F 03466	95	10	1215	2	32.5	3.38	42	15	-	71
F 03467	95	12	1215	2	42	3.45	42	25	-	71
F 03468	95	16	1215	4	52	3.77	42	22	-	71
F 03469	100	6	1610	2	13.5	3.24	26	12.5	-	76
F 03470	100	8	1610	2	23	3.31	26	22	-	76
F 03471	100	10	2012	2	32.5	3.38	32	25	-	79
F 03472	100	12	2012	2	42	3.45	32	35	-	79
F 03473	100	16	2012	4	52	3.77	32	27	-	79
F 03474	106	6	1610	2	13.5	3.24	26	12.5	-	82
F 03475	106	8	1610	2	23	3.31	26	22	-	82
F 03476	106	10	2012	2	32.5	3.38	32	25	-	82
F 03477	106	12	2012	2	42	3.45	32	35	-	82
F 03478	106	16	2012	4	52	3.77	32	27	-	82
F 03479	112	6	1610	2	13.5	3.24	26	12.5	-	88
F 03480	112	8	1610	2	23	3.31	26	22	-	88
F 03481	112	10	2012	2	32.5	3.38	32	25	-	88
F 03482	112	12	2012	2	42	3.45	32	35	-	88
F 03483	112	16	2012	4	52	3.77	32	27	-	88
F 03484	118	6	2012	2	13.5	3.24	32	6.5	-	94
F 03485	118	8	2012	2	23	3.31	32	16	-	94
F 03486	118	10	2517	4	32.5	3.38	45	6	-	97
F 03487	118	12	2517	4	42	3.45	45	11	-	97
F 03488	118	16	2517	4	52	3.77	45	20.5	-	97
F 03489	118	20	2517	4	105	7.85	45	30	-	97

Rozměry uvedeny v mm.

Řemenice pro drážkové řemeny Micro-V® pro TaperLock®

Materiál

Šedá litina



Pro řemeny L

Obj. číslo	Vnější Ø de	Počet drážek	Pouzdro TaperLock®	Provedení	W	S	L	Z	M	U
F 03490	125	6	2012	2	13.5	3.24	32	6.5	-	101
F 03491	125	8	2012	2	23	3.31	32	16	-	101
F 03492	125	10	2517	4	32.5	3.38	45	6	-	101
F 03493	125	12	2517	4	42	3.45	45	11	-	101
F 03089	125	16	2517	4	52	3.77	45	20.5	-	101
F 03495	125	20	2517	4	105	7.85	45	30	-	101
F 03494	132	6	2012	2	13.5	3.24	32	6.5	-	108
F 03678	132	8	2012	2	23	3.31	32	16	-	108
F 03679	132	10	2517	4	32.5	3.38	45	6	-	108
F 03680	132	12	2517	4	42	3.45	45	11	-	108
F 03681	132	16	2517	4	52	3.77	45	20.5	-	108
F 03682	132	20	2517	4	105	7.85	45	30	-	108
F 03683	140	6	2517	7	13.5	3.24	45	6.5	-	120
F 03684	140	8	2517	2	23	3.31	45	3	-	116
F 03685	140	10	2517	4	32.5	3.38	45	6	-	116
F 03686	140	12	2517	4	42	3.45	45	11	-	116
F 03687	140	16	2517	4	52	3.77	45	20.5	-	116
F 03688	140	20	3020	4	105	7.85	52	26.5	-	116
F 03689	150	6	2517	7	13.5	3.24	45	6.5	120	-
F 03690	150	8	2517	2	23	3.31	45	3	-	126
F 03691	150	10	2517	4	32.5	3.38	45	6	-	126
F 03692	150	12	2517	4	42	3.45	45	11	-	126
F 03693	150	16	2517	4	52	3.77	45	20.5	-	126
F 03694	150	20	3020	4	105	7.85	52	26.5	-	126
F 03695	160	6	2517	7	13.5	3.24	45	6.5	120	-
F 03696	160	8	2517	2	23	3.31	45	3	-	136
F 03697	160	10	2517	4	32.5	3.38	45	6	-	136
F 03698	160	12	2517	4	42	3.45	45	11	-	136
F 03699	160	16	3020	4	52	3.77	52	17	-	136
F 03700	160	20	3020	4	105	7.85	52	26.5	-	136
F 03701	170	6	2517	8	13.5	3.24	45	6.5	120	146
F 03702	170	8	2517	2	23	3.31	45	3	-	146
F 03703	170	10	2517	4	32.5	3.38	45	6	-	146
F 03704	170	12	2517	4	42	3.45	45	11	-	146
F 03705	170	16	3020	4	52	3.77	52	17	-	146
F 03706	170	20	3020	4	105	7.85	52	26.5	-	146
F 03709	180	6	2517	6	13.5	3.24	45	3.25	120	156
F 03710	180	8	2517	5	23	3.31	45	1.5	120	156
F 03712	180	10	2517	5	32.5	3.38	45	6	120	156
F 03713	180	12	2517	5	42	3.45	45	11	120	156
F 03088	180	16	3020	4	52	3.77	52	17	-	156
F 03714	180	20	3020	4	105	7.85	52	26.5	-	156

Rozměry uvedeny v mm.

Řemenice pro drážkové řemeny Micro-V® pro TaperLock®

Materiál

Šedá litina



Pro řemeny L

Obj. číslo	Vnější Ø de	Počet drážek	Pouzdro TaperLock®	Provedení	W	S	L	Z	M	U
F 03715	190	6	2517	6	13.5	3.24	45	3.25	120	166
F 03716	190	8	2517	5	23	3.31	45	1.5	120	166
F 03717	190	10	2517	5	32.5	3.38	45	6	120	166
F 03718	190	12	2517	5	42	3.45	45	11	120	166
F 03719	190	16	3020	5	52	3.77	52	17	146	166
F 03720	190	20	3020	5	105	7.85	52	26.5	146	166
F 03721	200	6	2517	6	13.5	3.24	45	3.25	120	176
F 03722	200	8	2517	5	23	3.31	45	1.5	120	176
F 03723	200	10	3020	5	32.5	3.38	52	2.5	146	176
F 03724	200	12	3020	5	42	3.45	52	7.5	146	176
F 03725	200	16	3020	5	52	3.77	52	17	146	176
F 03726	200	20	3535	4	105	7.85	89	8	-	176
F 03727	212	6	2517	6	13.5	3.24	45	3.25	120	188
F 03728	212	8	2517	5	23	3.31	45	1.5	120	188
F 03729	212	10	3020	5	32.5	3.38	52	2.5	146	188
F 03730	212	12	3020	5	42	3.45	52	7.5	146	188
F 03731	212	16	3020	5	52	3.77	52	17	146	188
F 03732	212	20	3535	4	105	7.85	89	8	-	188
F 03733	224	6	2517	6	13.5	3.24	45	3.25	120	202
F 03734	224	8	2517	5	23	3.31	45	1.5	120	202
F 03735	224	10	3020	5	32.5	3.38	52	2.5	146	202
F 03736	224	12	3020	5	42	3.45	52	7.5	146	202
F 03737	224	16	3020	5	52	3.77	52	17	146	202
F 03738	224	20	3535	5	105	7.85	89	8	178	202
F 03739	236	6	2517	6	13.5	3.24	45	3.25	120	214
F 03740	236	8	2517	5	23	3.31	45	1.5	120	214
F 03741	236	10	3020	5	32.5	3.38	52	2.5	146	214
F 03742	236	12	3020	5	42	3.45	52	7.5	146	214
F 03743	236	16	3020	5	52	3.77	52	17	146	214
F 03744	236	20	3535	5	105	7.85	89	8	178	214
F 03745	250	6	2517	9	13.5	3.24	45	3.25	120	228
F 03746	250	8	2517	5	23	3.31	45	1.5	120	228
F 03747	250	10	3020	5	32.5	3.38	52	2.5	146	228
F 03748	250	12	3020	5	42	3.45	52	7.5	146	228
F 03749	250	16	3020	5	52	3.77	52	17	146	228
F 03750	250	20	3535	5	105	7.85	89	8	178	226
F 03751	280	6	2517	6	13.5	3.24	45	3.25	120	256
F 03752	280	8	3020	6	23	3.31	52	2	146	256
F 03753	280	0	3020	5	32.5	3.38	52	2.5	146	256
F 03754	280	12	3020	5	42	3.45	52	7.5	146	256
F 03755	280	16	3535	6	52	3.77	89	1.5	178	256
F 03756	280	20	3535	5	105	7.85	89	8	178	256

Rozměry uvedeny v mm.

Řemenice pro drážkové řemeny Micro-V® pro TaperLock®

Materiál

Šedá litina



Pro řemeny L

Obj. číslo	Vnější Ø de	Počet drážek	Pouzdro TaperLock®	Provedení	W	S	L	Z	M	U
F 03757	315	6	2517	9	13.5	3.24	45	3.25	120	285
F 03758	315	8	3020	9	23	3.31	52	2	146	285
F 03759	315	10	3535	6	32.5	3.38	89	16	178	285
F 03760	315	12	3535	6	42	3.45	89	11	178	285
F 02641	315	16	3535	6	52	3.77	89	1.5	178	285
F 03761	315	20	4040	5	105	7.85	102	1.5	215	285
F 03762	355	6	3020	9	13.5	3.24	52	6.75	146	325
F 03763	355	8	3020	9	23	3.31	52	2	146	325
F 03764	355	10	3535	9	32.5	3.38	89	16	178	325
F 03765	355	12	3535	9	42	3.45	89	11	178	325
F 03766	355	16	3535	9	52	3.77	89	1.5	178	325
F 03767	355	20	4040	5	105	7.85	102	1.5	215	325
F 03768	400	6	3020	9	13.5	3.24	52	6.75	146	370
F 03769	400	8	3020	9	23	3.31	52	2	146	370
F 03770	400	10	3535	9	32.5	3.38	89	16	178	370
F 03771	400	12	3535	9	42	3.45	89	11	178	370
F 03772	400	16	3535	9	52	3.77	89	1.5	178	370
F 03773	400	20	4040	10	105	7.85	102	1.5	215	370
F 03774	450	6	3020	9	13.5	3.24	52	6.75	146	420
F 03775	450	8	3020	9	23	3.31	52	2	146	420
F 03776	450	10	3535	9	32.5	3.38	89	16	178	420
F 03777	450	12	3535	9	42	3.45	89	11	178	420
F 03778	450	16	3535	9	52	3.77	89	1.5	178	420
F 03779	450	20	4040	9	105	7.85	102	1.5	215	420
F 03780	500	6	3020	9	13.5	3.24	52	6.75	146	470
F 03781	500	8	3020	9	23	3.31	52	2	146	470
F 03782	500	10	3535	9	32.5	3.38	89	16	178	470
F 03783	500	12	3535	9	42	3.45	89	11	178	470
F 03784	500	16	3535	9	52	3.77	89	1.5	178	470
F 03785	500	20	5050	9	105	7.85	127	11	267	470
F 03786	630	6	3020	9	13.5	3.24	52	6.75	146	600
F 03787	630	8	3020	9	23	3.31	52	2	146	600
F 03788	630	10	3535	9	32.5	3.38	89	16	178	600
F 03789	630	12	3535	9	42	3.45	89	11	178	600
F 03790	630	16	4040	9	52	3.77	102	8	215	600
F 03791	630	20	5050	9	105	7.85	127	11	267	600
F 03792	800	6	3535	9	13.5	3.24	89	25.2	178	770
F 03793	800	8	3535	9	23	3.31	89	20.5	178	770
F 03794	800	10	4040	9	32.5	3.38	102	22.5	215	770
F 03795	800	12	4040	9	42	3.45	102	17.5	215	770
F 03796	800	16	5050	9	52	3.77	127	20.5	267	770
F 03797	800	20	5050	9	105	7.85	127	11	267	770

Rozměry uvedeny v mm.